

# Start

JUNE 2018

The logo for Loran, featuring the word "Loran" in a stylized, italicized font with a horizontal line under the "L". Below it, the tagline "everyday passion" is written in a smaller, lowercase font.

*Loran*  
everyday passion

### MODULI

Aggiungere ad ogni elemento il prezzo del supporto a pavimento o a muro (serie Vela) e del basamento o supporto (serie Start), del piano, dell'alzatina, del lavello e del rubinetto.

I moduli su misura possono essere realizzati solo con anta: applicare il prezzo dell'articolo di misura superiore con un supplemento del 25%.

### PENSILI E VETRINE

Pensili e vetrine su misura: applicare il prezzo dell'articolo di misura superiore con un supplemento del 25%.

### ATTENZIONE

Indicare sempre le misure delle apparecchiature che devono essere inserite nei moduli.

Le composizioni si intendono sempre a partire da sinistra verso destra.

Specificare i colori di fusto, frontali e maniglie dei moduli.

Specificare dimensioni e tipo di piano, alzatina, lavello e rubinetto.

Composizioni lineari con canalina tecnica e lavello: utilizzare piani con profondità minima 520 mm.

Per composizioni con elementi ad angolo verificare la perpendicolarità delle pareti (90°): considerando la distanza di 80 cm. su una parete e 60 cm. sull'altra, la diagonale deve corrispondere a 100 cm.

Dimensioni: L = Larghezza P = Profondità H = Altezza

### MANIGLIE ALLUMINIO "FAM"

I moduli Start e Steril Center, su richiesta, possono essere forniti con maniglie "FAM" (vedi pag. 69) senza supplemento di prezzo.

(N.B.: solo in alluminio, no verniciate).

### CORIAN® e STRATIFICATO: solo di colore bianco.

### MAGGIORAZIONI DI PREZZO PER COLORAZIONI SPECIALI

Colori RAL metallizzati/perlati e brillanti e in altri colori diversi dalla cartella RAL:

- Fusto (Start): supplemento per ogni mobile + € 180,00
- Serie frontali/anta: supplemento per ogni mobile + € 100,00
- Maniglie Start e di traino supplemento per ogni maniglia + € 16,00

**SPESE IMBALLO:** ogni collo € 15,00 prezzo netto.

### UNITS

Add the floor support or wall support price (Vela) and the base or support price (Start), the top, splashback, sink and mixer prices to each unit.

Made-to-measure units: apply the price of the article with the next greater size and add a 25% extra charge.

### WALL UNITS AND DISPLAY CABINETS

Made-to-measure wall units and display cabinets: apply the price of the article with the next greater size and add a 25% extra charge.

### ATTENTION

Always provide the dimensions of the appliances that will be built into the units. The compositions are always understood as starting from the left to the right.

Specify the colours of the unit, front panels and handles.

Specify the dimensions and type of top, splashback, sink and mixer.

Straight compositions with technical raceway and sink: use tops with minimum depth 520 mm.

For compositions with corner elements check that the walls are perfectly perpendicular (90°): considering the distance of 80 cm on the right and 60 cm left hand sides of the corner, the diagonal line must be 100 cm.

Dimensions: L = Width P = Depth  
H = Height

### ALUMINIUM HANDLE "FAM"

Upon request, the furniture can be supplied with handles "FAM" (see page 69) without extra charge.

(Please note: only aluminum, NOT painted).

**CORIAN® and STRATIFIED: only in white color.**

### UPCHARGES FOR SPECIAL COLORS

Metallized/pearl and luminous RAL colors and other different colors from the RAL colors:

- Unit (Start): upcharge for each unit +€ 180,00
- Fronts/door: upcharge for each unit +€ 100,00
- Painted handles: upcharge for each handle +€ 16,00

### PACKING COSTS:

each package € 15.00 net price

## Specifications / Spezifikationen / Especificaciones

### MODULES

À chaque module il faut ajouter le prix de support au sol au support ou mur (Vela), base ou support (Start), plan, dossier, évier et robinet. Les modules sur mesure peuvent être réalisés uniquement avec une porte: appliquer le prix de l'article de mesure supérieure et ajouter un supplément de 25%.

### ÉLÉMENTS MURAUX ET VITRINES

Éléments suspendus et vitrines sur mesure: appliquer le prix de l'article de mesure supérieure et ajouter un supplément de 25%.

### ATTENTION

Indiquer obligatoirement les mesures exactes des appareils destinés à être introduits dans les meubles. Les compositions s'entendent toujours en partant de gauche vers la droite. Spécifier les couleurs du corps, des façades et des poignées des modules. Spécifier les dimensions et le type du plan, du dossier, du lavabo et du robinet. Compositions linéaires avec canalisation technique et évier: utiliser des plans ayant une profondeur minimale de 520 mm. Pour les compositions avec des éléments d'angle, contrôler soigneusement la perpendicularité des murs (90°): si on prend la distance exacte de 80 cm à droite et 60 cm à gauche de l'angle, la diagonale devra mesurer 100 cm.

Dimensions: L = Largeur P = Profondeur  
H = Hauteur

### POIGNÉE EN ALUMINIUM "FAM"

Sur demande, les meubles peuvent être fournis avec poignées "FAM" (voir page 69) sans frais supplémentaires. (Attention: en aluminium, PAS peint).

### CORIAN® et STRATIFIE': en couleur blanc seulement.

### SUPPLÉMENTS DE PRIX POUR COULEURS SPÉCIALES

Couleurs RAL métallisés/pearl et lumineux et d'autres couleurs différentes des couleurs RAL:  
- Module (Start): supplément de prix pour chaque module +€ 180,00  
- Façades/porte: supplément de prix pour chaque module +€ 100,00  
- Poignées peintes: supplément de prix pour chaque poignée +€ 16,00

### FRAIS D'EMBALLAGE:

prix net de chaque colis € 15,00

### SCHRÄNKE

Bei jedem Element muss der Preis der Bodengestell oder der Wandbefestigung (Vela), und des Sockel oder des Gestell (Start), der Arbeitsplatte, der Aufkantung, der Spüle und der Wasserhahn separat berechnet werden. Maßgefertigte Schränke können nur mit Tür hergestellt werden: auf den Preis des nächst größeren Artikels einen Mehrpreis von 25% berechnen.

### HÄNGESCHRÄNKE UND VITRINEN

Maßgefertigte Hängeschränke und Vitrinen: auf den Preis des nächst größeren Artikels einen Mehrpreis von 25% berechnen.

### VORSICHT

Immer die Maße der Geräte angeben, die in die Schränke eingebaut werden. Die Anbaulösungen sind immer von links nach rechts angeben. Die Farben des Korpus, der Fronten und der Griffe der Schränke angeben. Abmessungen und Art der Arbeitsplatte, Aufkantung, Spüle und Wasserhahn angeben. Lineare Anbaulösungen mit Technikkanal und Spüle: Arbeitsplatten mit einer Mindesttiefe von 520 mm verwenden. Bei Anbaulösungen mit Eckelementen auf lotrechte (90°) Wände achten: bei einem Abstand von 80 cm rechts und 60 cm links von der Ecke muss die Diagonale 100 cm betragen.

Abmessungen: L = Breite P = Tief  
H = Höhe

### "FAM" ALUMINIUMGRIFF

Auf Wunsch können die Schränke mit Griffen "FAM" (siehe Seite 69) ohne Aufpreis geliefert werden. (Bitte beachten: Aluminium, NICHT lackiert).

### CORIAN® und SCHICHTSTOFF: nur weiß.

### AUFPREIS FÜR SONDERFARBEN

Metallic/Perl und leuchtende RAL-Farben und anderen verschiedenen Farben der RAL-Farben:  
- Schrank (Start): Aufpreis für jede Schrank +€ 180,00  
- Fronten/Tür: Aufpreis für jede Schrank +€ 100,00  
- Lackierte Griffe: Aufpreis für jede Griff +€ 16,00

### VERPACKUNGSKOSTEN:

jedes Paket € 15,00 Nettopreis

### MÓDULOS

Añadir a cada elemento el precio del soporte de pie o del soporte en pared (Vela), y de la base o del soporte (Start), de la encimera, de la alzada, del lavabo y del grifo. Los muebles a la medida pueden realizarse sólo con la puerta: aplicar el precio del artículo de medida superior con un recargo del 25%.

### MUEBLES COLGANTES Y VITRINAS

Muebles colgantes y vitrinas a la medida: aplicar el precio del artículo de medida superior con un recargo del 25%.

### ATENCIÓN

Indicar siempre las medidas de los equipos que deben introducirse en los módulos. Las composiciones se consideran siempre a partir de la izquierda hacia la derecha. Especificar los colores del módulo, de los frentes y de los tiradores. Especificar las dimensiones y el tipo de encimera, de alzada, de lavabo y de grifo. Composiciones lineales con canal técnico y lavabo: utilizar encimeras con 520 mm de profundidad mínima. Para composiciones con elementos en ángulo controlar la perpendicularidad de las paredes (90°): considerando la distancia de 80 cm a la dcha. y 60 cm a la izq. del ángulo, la diagonal debe corresponder a 100 cm.

Dimensiones: L = Ancho P = Profundidad  
H = Alto

### TIRADOR DE ALUMINIO "FAM"

Previa solicitud, los muebles se pueden suministrar con tiradores "FAM" (ver página 69) sin cargo extra. (Atención: el aluminio, no pinta).

### CORIAN® y ESTRATIFICADO: de color blanco.

### CARGOS ADICIONAL PARA COLORACIONES ESPECIALES

Colores RAL metalizados/perla y brillantes y otros colores diferentes de colores RAL:  
- Módulo (Start): cargo adicional por cada módulo +€ 180,00  
- Frentes/puerta: cargo adicional por cada módulo +€ 100,00  
- Tiradores pintados: cargo adicional por cada tirador +€ 16,00

### EMBALAJE:

cada paquete € 15,00 precio neto

## Guida alla composizione delle linee START e STERIL CENTER

How to use this price list / Comment utiliser ce tarif  
Wie verwendet man diese Preisliste / Como utilizar esta lista de precios

Per le linee START e STERIL CENTER sono previste diverse soluzioni che si identificano con le lettere B e S. Partendo da elementi comuni (i moduli) le soluzioni si differenziano secondo la tipologia del **basamento/supporto** e della **cornice**.

Per una maggiore esemplificazione si vedano le pagine:

START\_B - START\_S: pag. 56  
STERIL CENTER\_B - STERIL CENTER\_S: pag. 73-74

---

The START and STERIL CENTER lines offer different solutions that are identified with the letters B and S. Except for some shared elements (units), the solutions differ in terms of types of **base units/supports** and **frames**.

For more information, see the following pages:

START\_B - START\_S: page 56  
STERIL CENTER\_B - STERIL CENTER\_S: pages 73-74

Pour les lignes START et STERIL CENTER plusieurs solutions sont prévues, identifiées par les lettres B et S. Partant d'éléments communs (les modules) les solutions se différencient par la **typologie de la base/du support** et de **l'encadrement**.

Pour plus d'informations et exemples, consulter les pages:

START\_B - START\_S: page 56  
STERIL CENTER\_B - STERIL CENTER\_S: pages 73-74

Bei den Produktreihen START und STERIL CENTER sind verschiedene Ausführungen erhältlich, die mit den Buchstaben B und S bezeichnet werden. Ausgehend von Basiselementen (Schränke) unterscheiden sich die Ausführungen je nach **Sockel/Gestell** und **Kranzblende**.

Für eine detaillierte Erläuterung wird auf die folgenden Seiten verwiesen:

START\_B - START\_S: Seite 56  
STERIL CENTER\_B - STERIL CENTER\_S: Seite 73-74

Para las líneas START y STERIL CENTER están previstas distintas soluciones que se identifican con las letras B y S. Partiendo de elementos comunes (los módulos) las soluciones se distinguen según el **tipo de base/soporte** y del **marco**.

Para una mayor ejemplificación véanse las páginas:

START\_B - START\_S: pág. 56  
STERIL CENTER\_B - STERIL CENTER\_S: pág. 73-74

## Linea Start

è composta dalle soluzioni Start\_B e Start\_S.

**Start\_B** si caratterizza per il **basamento chiuso** alto 160 mm, posto alla base del modulo.

**Start\_S** si caratterizza per il **supporto** che rialza il modulo di 160 mm da terra, per permettere una facile e pratica pulizia sotto al mobile.

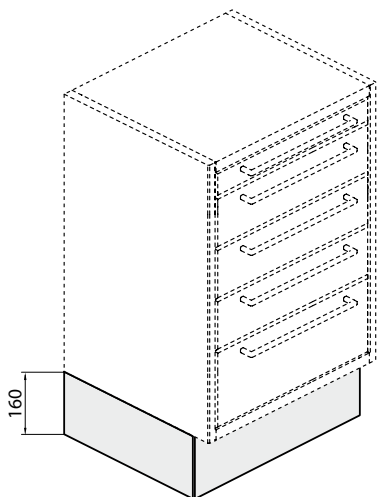

### Start\_B

**BASAMENTO H 160 mm**  
sotto al modulo

BASE UNIT  
H 160 mm  
under the unit

BASE  
H 160 mm  
sous le module

SOCKEL  
H 160 mm  
unter dem Schrank

BASE  
de 160 mm de alto  
debajo del módulo

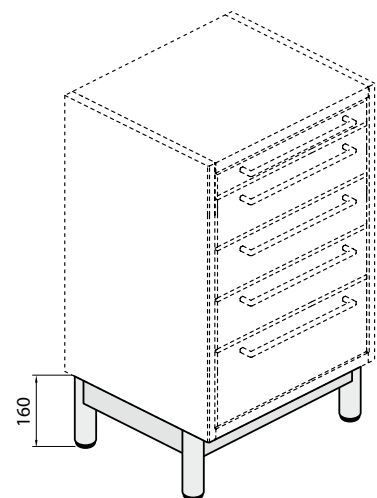

### Start\_S

**SUPPORTO H 160 mm**  
sotto al modulo

SUPPORT  
H 160 mm  
under the unit

SUPPORT  
H 160 mm  
sous le module

GESTELL  
H 160 mm  
unter dem Schrank

SOPORTE  
de 160 mm de alto  
debajo del módulo

The **Start Line** envisages the solutions **Start\_B** and **Start\_S**.

**Start\_B** is characterised by a **closed base unit**, height 160 mm, located at the base of the unit.

**Start\_S** is characterised by a **support** that raises the unit 160 mm from the floor, to allow easy and practical cleaning under the furniture.

La **Ligne Start** comprend les solutions **Start\_B** et **Start\_S**.

**Start\_B** est caractérisée par sa **base fermée**, de 160 mm de hauteur, située à la base du module.

**Start\_S** est caractérisée par son **support** qui rehausse le module de 160 mm par rapport au sol, pour permettre un nettoyage facile et pratique sous le module.

**Linea Start** umfasst die Ausführungen **Start\_B** und **Start\_S**.

**Start\_B** unterscheidet sich durch einen 160 mm hohen **Sockel** unter dem Schrank.

**Start\_S** unterscheidet sich durch ein **Gestell**, das einen Bodenabstand von 160 mm zum Schrank herstellt, wodurch auch unter dem Schrank die leichte Reinigung möglich ist.

**Línea Start** está constituida por las soluciones **Start\_B** y **Start\_S**.

**Start\_B** se caracteriza por la **base cerrada** de 160 mm de alto, posicionada en la base del módulo.

**Start\_S** se caracteriza por el **soporte** que sobrealza el módulo de 160 mm del suelo, para permitir una fácil y cómoda limpieza debajo del módulo.

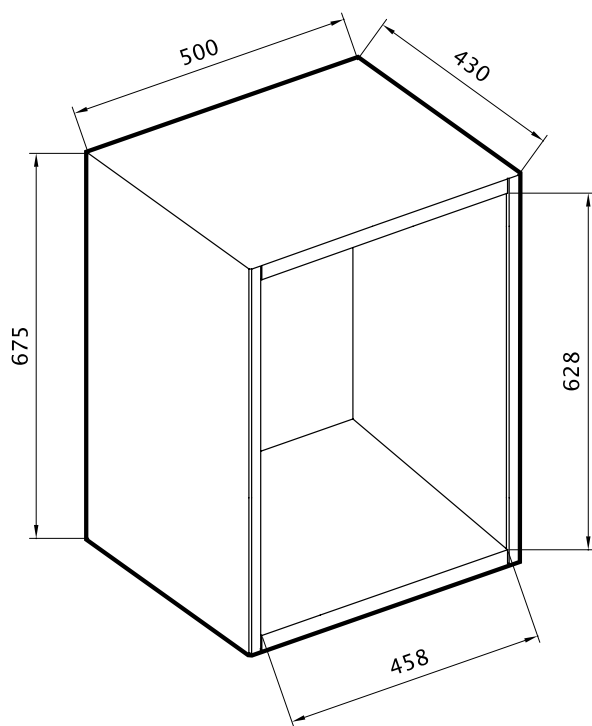

## FUSTO

Le misure sono espresse in mm.

### STRUCTURE

The dimensions are given in mm.

### CORPS

Les mesures sont exprimées en mm.

### KORPUS

Die Maße sind in mm angegeben.

### MODULO

Las medidas se expresan en mm.

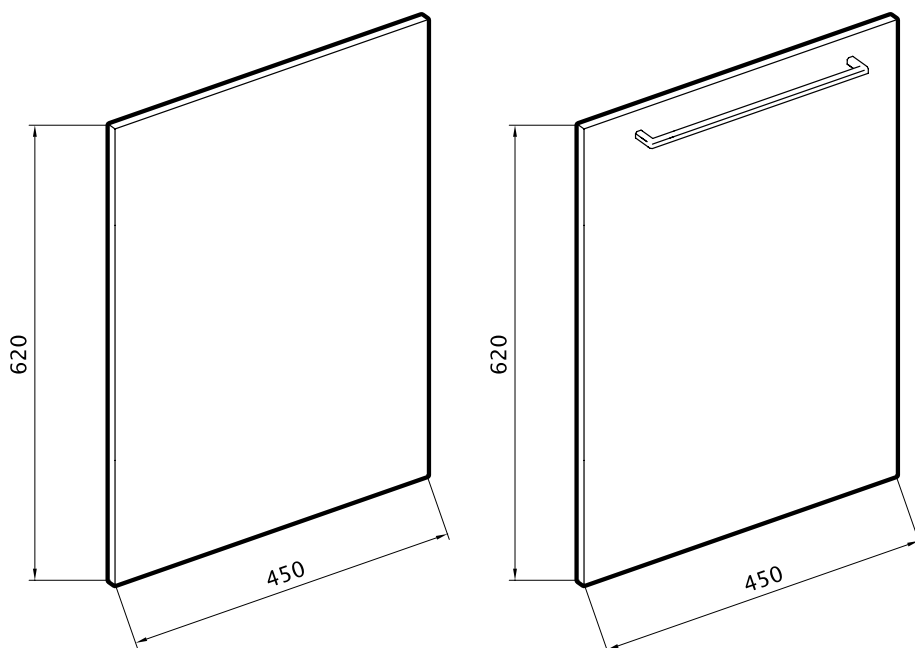

## FRONTALI

Le misure sono espresse in mm.

### FRONT PANELS

The dimensions are given in mm.

### FAÇADES

Les mesures sont exprimées en mm.

### FRONTEN

Die Maße sind in mm angegeben.

### FRENTES

Las medidas se expresan en mm.

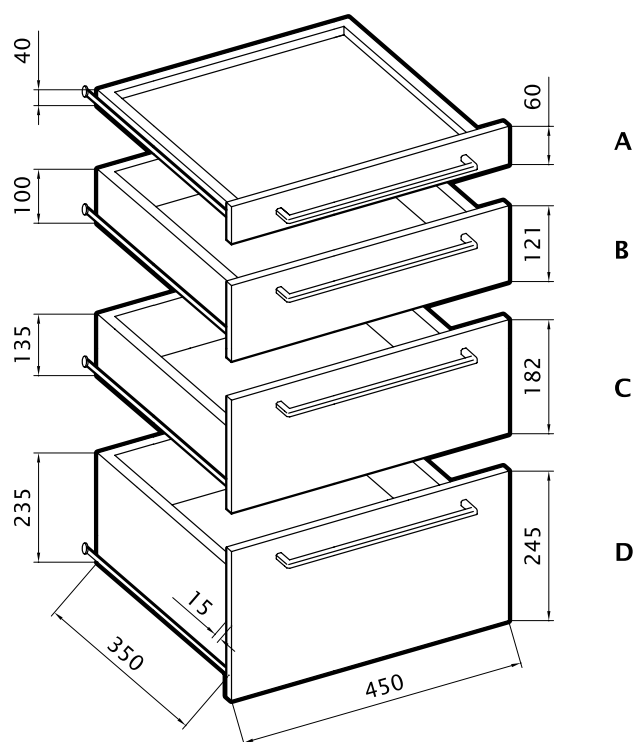
**CASSETTI**

Le misure sono espresse in mm.

**DRAWERS**

The dimensions are given in mm.

**TIROIRS**

Les mesures sont exprimées en mm.

**SCHUBLADEN**

Die Maße sind in mm angegeben.

**CAJONES**

Las medidas se expresan en mm.

I cassetti Start sono disponibili in 4 differenti altezze. Vengono indicati con le lettere A, B, C e D ed hanno tutti **guide scorrevoli su ruote teflonate**.

I moduli della linea Start vengono già proposti con combinazioni variabili delle diverse tipologie di cassetti, con un occhio sempre attento alla funzionalità d'utilizzo.

The Start drawers are available in 4 different heights. They are marked with the letters A, B, C and D and they all have **sliding guides on Teflon-coated castors**.

The Start units are already provided with varying combinations of the different types of drawers to be perfectly functional.

Les tiroirs Start sont disponibles dans 4 hauteurs différentes. Ils sont indiqués avec les lettres A, B, C et D et ont tous des **coulisseaux sur roues téflonisées**.

Les modules de la ligne Start sont déjà proposés avec des combinaisons variables des différentes typologies de tiroirs, avec un regard toujours attentif à la fonctionnalité d'utilisation.

Die Schubladen Start sind in 4 verschiedenen Höhen erhältlich. Sie werden mit den Buchstaben A, B, C und D bezeichnet und haben alle **Gleitführungen auf teflonbeschichteten Rollen**.

Die Start Module werden bereits in unterschiedlichen Kombinationen der verschiedenen Schubkästen angeboten, wobei die Funktionalität immer maßgebend ist.

Los cajones Start están disponibles en 4 distintas alturas. Se indican con las letras A, B, C y D y todos están provistos de **guías correderas sobre ruedas teflonadas**.

Los módulos de la línea Start ya están disponibles con combinaciones variables de los distintos tipos de cajones, con un ojo siempre atento a la funcionalidad de utilización.

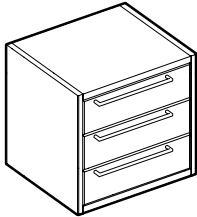
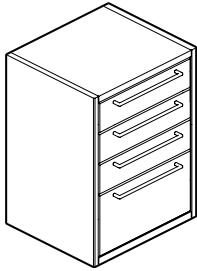
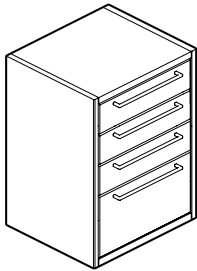
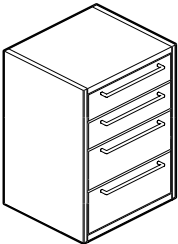
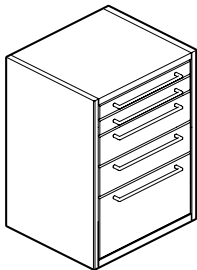
	Descrizione / Description Description / Beschreibung / Descripción	M <sup>3</sup> Kg	Articolo Item / Article Artikel / Artículo
 <p><b>Modulo con 3 cassetti B</b> Unit with 3 drawers B Module avec 3 tiroirs B Schrank mit 3 Schubladen B Módulo con 3 cajones B</p> <p><b>Bacelle/Trays/Intérieurs de tiroir/Einsätze/Bandejas:</b> 1x9B, 1x10B, 1x11B</p> <p>L 500 x P 430 x H 426 mm</p>		0,25 ----- 15,5	SF3_
 <p><b>Modulo con 3 cassetti B e antina</b> Unit with 3 drawers B and door Module avec 3 tiroirs B et porte Schrank mit 3 Schubladen B und Tür Módulo con 3 cajones B y puerta</p> <p><b>Bacelle/Trays/Intérieurs de tiroir/Einsätze/Bandejas:</b> 1x9B, 1x10B, 1x11B</p> <p>L 500 x P 430 x H 675 mm</p>		0,25 ----- 25,5	SF3P_
 <p><b>Modulo con 4 cassetti: 3B e 1D</b> Unit with 4 drawers: 3B and 1D Module avec 4 tiroirs: 3B et 1D Schrank mit 4 Schubladen: 3B und 1D Módulo con 4 cajones: 3B y 1D</p> <p><b>Bacelle/Trays/Intérieurs de tiroir/Einsätze/Bandejas:</b> 1x9B, 1x10B, 1x11B</p> <p>L 500 x P 430 x H 675 mm</p>		0,25 ----- 28	SF3C_
 <p><b>Modulo con 4 cassetti: 2B e 2C</b> Unit with 4 drawers: 2B and 2C Module avec 4 tiroirs: 2B et 2C Schrank mit 4 Schubladen: 2B und 2C Módulo con 4 cajones: 2B y 2C</p> <p><b>Bacelle/Trays/Intérieurs de tiroir/Einsätze/Bandejas:</b> 1x9B, 1x10B</p> <p>L 500 x P 430 x H 675 mm</p>		0,25 ----- 28	SF4
 <p><b>Modulo con 2 cassetti A, 2B e antina</b> Unit with 2 drawers A, 2B and door Module avec 2 tiroirs A, 2B et porte Schrank mit 2 Schubladen A, 2B und Tür Módulo con 2 cajones A, 2B y puerta</p> <p><b>Bacelle/Trays/Intérieurs de tiroir/Einsätze/Bandejas:</b> 1x1A, 1x7A, 1x9B, 1x10B</p> <p>L 500 x P 430 x H 675 mm</p>		0,25 ----- 26,5	SF4P_

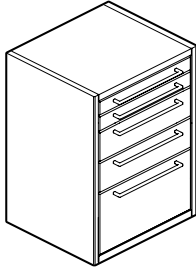
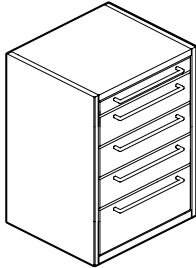
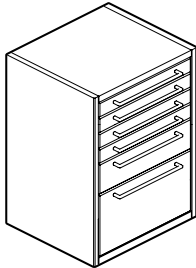
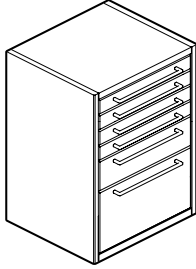
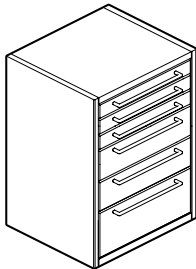

	Descrizione / Description Description / Beschreibung / Descripción	M <sup>3</sup> Kg	Articolo Item / Article Artikel / Artículo
 <p><b>Modulo con 5 cassetti: 2A, 2B e 1 D</b> Unit with 5 drawers: 2A, 2B and 1D Module avec 5 tiroirs: 2A, 2B et 1D Schrank mit 5 Schubladen: 2A, 2B und 1D Módulo con 5 cajones: 2A, 2B y 1D</p> <p><b>Bacelle/Trays/Intérieurs de tiroir/Einsätze/Bandejas:</b> 1x1A, 1x7A, 1x9B, 1x10B</p> <p>L 500 x P 430 x H 675 mm</p>		0,25 ----- 29,5	SF4C_
 <p><b>Modulo con 5 cassetti: 1A, 3B e 1C</b> Unit with 5 drawers: 1A, 3B and 1C Module avec 5 tiroirs: 1A, 3B et 1C Schrank mit 5 Schubladen: 1A, 3B und 1C Módulo con 5 cajones: 1A, 3B y 1C</p> <p><b>Bacelle/Trays/Intérieurs de tiroir/Einsätze/Bandejas:</b> 1x1A, 1x9B, 1x10B, 1x11B</p> <p>L 500 x P 430 x H 675 mm</p>		0,25 ----- 30	SF5_
 <p><b>Modulo con 4 cassetti A, 1B e antina</b> Unit with 4 drawers A, 1B and door Module avec 4 tiroirs A, 1B et porte Schrank mit 4 Schubladen A, 1B und Tür Módulo con 4 cajones A, 1B y puerta</p> <p><b>Bacelle/Trays/Intérieurs de tiroir/Einsätze/Bandejas:</b> 1x1A, 1x2A, 1x3A, 1x7A, 1x9B</p> <p>L 500 x P 430 x H 675 mm</p>		0,25 ----- 29	SF5P_
 <p><b>Modulo con 6 cassetti: 4A, 1B e 1D</b> Unit with 6 drawers: 4A, 1B and 1D Module avec 6 tiroirs: 4A,1B et 1D Schrank mit 6 Schubladen: 4A, 1B und 1D Módulo con 6 cajones: 4A, 1B y 1D</p> <p><b>Bacelle/Trays/Intérieurs de tiroir/Einsätze/Bandejas:</b> 1x1A, 1x2A, 1x3A, 1x7A, 1x9B</p> <p>L 500 x P 430 x H 675 mm</p>		0,25 ----- 31,5	SF5C_
 <p><b>Modulo con 6 cassetti: 3A, 2B e 1C</b> Unit with 6 drawers: 3A, 2B and 1C Module avec 6 tiroirs: 3A, 2B et 1C Schrank mit 6 Schubladen: 3A, 2B und 1C Módulo con 6 cajones: 3A, 2B y 1C</p> <p><b>Bacelle/Trays/Intérieurs de tiroir/Einsätze/Bandejas:</b> 1x1A, 1x2A, 1x3A, 1x9B, 1x10B</p> <p>L 500 x P 430 x H 675 mm</p>		0,25 ----- 32	SF6_

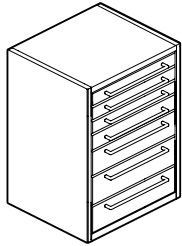
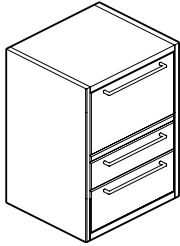
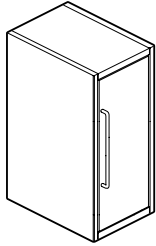
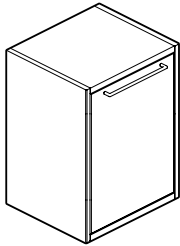
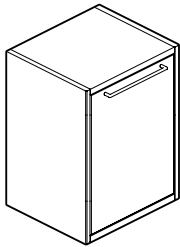
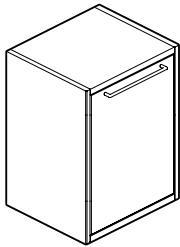
	Descrizione / Description Description / Beschreibung / Descripción	M <sup>3</sup> Kg	Articolo Item / Article Artikel / Artículo
 <b>L 500 x P 430 x H 675 mm</b>	<p><b>Modulo con 7 cassetti: 4A e 3B</b>            Unit with 7 drawers: 4A and 3B            Module avec 7 tiroirs: 4A et 3B            Schrank mit 7 Schubladen: 4A und 3B            Módulo con 7 cajones: 4A y 3B</p> <p><b>Bacelle/Trays/Intérieurs de tiroir/Einsätze/Bandejas:</b>  <b>1x1A, 1x2A, 1x3A, 1x7A, 1x9B, 1x10B, 1x11B</b></p>	0,25 ----- 34,5	SF7_
 <b>L 500 x P 430 x H 675 mm</b>	<p><b>MODULO con anta a ribalta con 2 ripiani estraibili per apparecchiature + ciabatta con 3 prese di corrente, 1 cassetto B e 1 C</b>            Unit with hide-away door equipped with 2 apparatus storage shelves + 3 Schuko sockets, 1 drawer B and 1 C            Module avec porte basculante avec 2 tiroirs pour appareils + 3 prises de courant Schuko, 1 tiroir B et 1 C            Schrank mit versenkbarer Tür mit 2 Geräteeinlagen + 3 Schuko-Steckdosen, 1 Schublade B und 1 C            Módulo con puerta plegable con 2 estantes extraíbles para equipos + regleta con 3 tomas de corriente Schuko, 1 cajón B y 1 C</p> <p><b>Bacelle/Trays/Intérieurs de tiroir/Einsätze/Bandejas: 1x11B</b></p>	0,25 ----- 25,5	SF22_
 <b>L 300/400 x P 430 x H 675 mm</b>	<p><b>Modulo con anta e 2 ripiani interni</b>            Unit with door and 2 interior shelves            Module avec porte et 2 étagères internes            Schrank mit Tür und 2 Einlegeböden            Módulo con puerta y 2 estantes interiores</p>	0,25 ----- 12,5	SFP-3_ (L. 300 mm)
 <b>L 500/600 x P 430 x H 675 mm</b>	<p><b>Modulo con anta e 2 ripiani interni</b>            Unit with door and 2 interior shelves            Module avec porte et 2 étagères internes            Schrank mit Tür und 2 Einlegeböden            Módulo con puerta y 2 estantes interiores</p>	0,25 ----- 21	SFP-5_ (L. 500 mm)
 <b>L 500/600 x P 430 x H 675 mm</b>	<p><b>Modulo con anta e 2 ripiani interni</b>            Unit with door and 2 interior shelves            Module avec porte et 2 étagères internes            Schrank mit Tür und 2 Einlegeböden            Módulo con puerta y 2 estantes interiores</p>	0,30 ----- 25	SFP-6_ (L. 600 mm)
 <b>L 500 x P 430 x H 675 mm</b>	<p><b>Modulo con frigorifero da incasso (lt. 40)</b>            Unit with built-in refrigerator (lt. 40)            Module avec réfrigérateur encastrable (lt. 40)            Schrank AF mit Kühlschrank (Lt. 40)            Módulo con nevera empotrada (lt. 40)</p>	0,25 ----- 34	SFF_

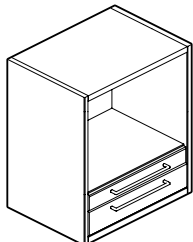
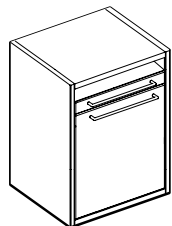
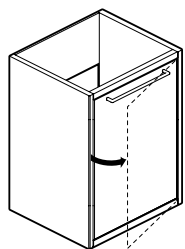
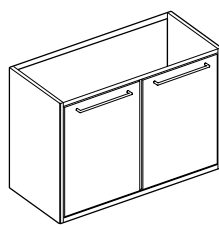
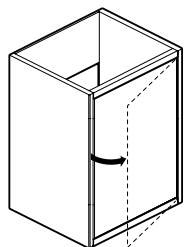
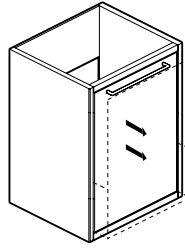
	<b>Descrizione / Description</b> Description / Beschreibung / Descripción	<b>M<sup>3</sup></b> <b>Kg</b>	<b>Articolo</b> Item / Article Artikel / Artículo
 <p><b>Modulo L 600 per autoclave con 1 cassetto in basso</b> L 600-unit for built-in autoclave, with 1 drawer Module L 600 pour autoclave encastrable, avec 1 tiroir B 600-Schrank zur Integration eines Autoklaven mit 1 Schublade Módulo L 600 para autoclave empotrada con un cajón</p> <p><b>L 600 x P 430 x H 675 mm</b></p>		0,30 25	SFAU_
 <p><b>Modulo PC con cassetto A per tastiera da appoggio e anta</b> Unit for PC with 1 drawer A for keyboard and door Module pour PC avec 1 tiroir A pour appuyer le clavier et porte Schrank für PC mit 1 Schublade für Tastatur und Tür Módulo PC con 1 cajón A para teclado y puerta</p> <p><b>L 500 x P 430 x H 675 mm</b></p>		0,25 22	SFPC_
 <p><b>MODULO sottolavello con anta e portarifiuti interno</b> Sink unit with door and rubbish bin Module lavabo avec porte et poubelle Waschbeckenschrank mit Tür und Abfalleimer Módulo lavabo con puerta y cubo de basura</p> <p><b>L 500/600 x P 430 x H 675 mm</b></p>		0,25 18	SL-I_ (L. 500 mm)
 <p><b>MODULO sottolavello con 2 ante e portarifiuti interno</b> Sink unit with 2 doors and rubbish bin Module lavabo avec 2 portes et poubelle Waschbeckenschrank mit 2 Türen und Abfalleimer Módulo lavabo con 2 puertas y cubo de basura</p> <p><b>L 1000 x P 430 x H 675 mm</b></p>		0,55 27	SL-I2_
 <p><b>Modulo sottolavello con anta intera apertura laterale a "ginocchio" e portarifiuti interno</b> Sink unit with knee-opening door and rubbish bin Module lavabo avec porte avec ouverture à genou et poubelle Waschbeckenschrank mit Tür mit Knieöffnung und Abfalleimer Módulo lavabo con puerta con apertura de codillo y cubo de basura</p> <p><b>L 500 x P 430 x H 675 mm</b></p>		0,25 18	SL-G_
 <p><b>Modulo sottolavello con cassettone estraibile e cestello portarifiuti interno</b> Sink unit with pull-out door and rubbish bin Module lavabo avec porte extractible et poubelle Waschbeckenschrank mit ausziehbarer Tür und Abfalleimer Módulo lavabo con puerta extraible y cubo de basura</p> <p><b>L 500 x P 430 x H 675 mm</b></p>		0,25 21	SL-C_

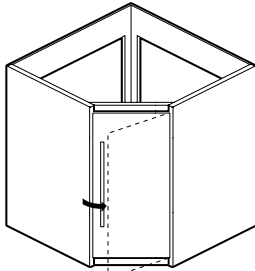
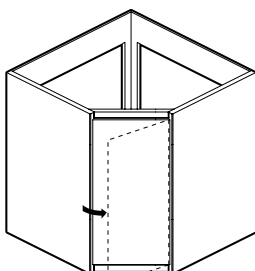
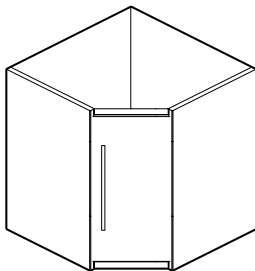
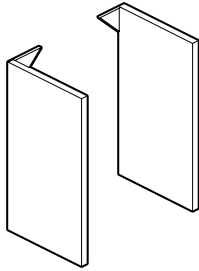
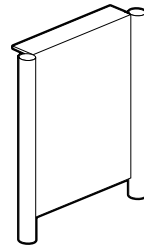
	Descrizione / Description Description / Beschreibung / Descripción	M <sup>3</sup> Kg	Articolo Item / Article Artikel / Artículo
 <p><b>MODULO angolare sottolavello con anta e portarifiuti interno</b> Corner sink unit with door and rubbish bin Module lavabo d'angle avec porte et poubelle Eckwaschbeckenschrank mit Tür und Abfalleimer Módulo angular lavabo con puerta y cubo de basura</p> <p><b>L 645 x P 645x H 675 mm</b></p>		0,50 ----- 20	SLA-I_
 <p><b>Modulo angolare sottolavello con anta intera apertura laterale a "ginocchio" e portarifiuti interno</b> Corner sink unit with knee-opening door and rubbish bin Module lavabo d'angle avec porte avec ouverture à genou et poubelle Eckwaschbeckenschrank mit Tür mit Knieöffnung und Abfalleimer Módulo angular lavabo con puerta con apertura de codillo y cubo de basura</p> <p><b>L 645 x P 645x H 675 mm</b></p>		0,50 ----- 20	SLA-G_
 <p><b>Modulo angolare con anta e 1 ripiano interno</b> Corner unit with door and 1 interior shelf Module d'angle avec porte et 1 étagère interne Eckschrank mit Tür und 1 Einlegeboden Módulo angular con puerta y 1 estante interior</p> <p><b>L 645 x P 645x H 675 mm</b></p>		0,50 ----- 21,5	SFA_
 <p><b>Pannello laterale sx o dx di sostegno piano</b> Left or right top-support side panel Panneau latéral, gauche ou droit, de support pour le plan Abschlußverkleidung (links oder rechts) Panel lateral, izquierdo o derecho, para el soporte de la encimera</p> <p><b>L 25 x P 430 x H 835 mm</b></p>		- ----- 6	SLS/SLD
 <p><b>Pannello laterale in tubolare di sostegno piano</b> Top-support side panel Panneau latéral en tubulaire, de support pour le plan Abschlußverkleidung aus Profilrohr Panel lateral en tubular, para el soporte de la encimera</p> <p><b>L 40 x P 430 x H 835 mm</b></p>		- ----- 6	SLT

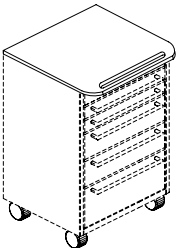
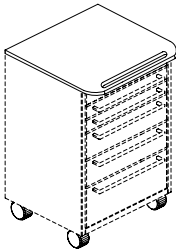
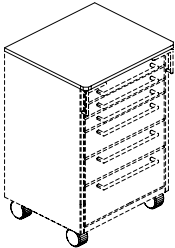
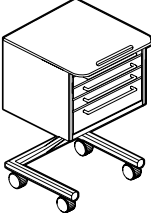
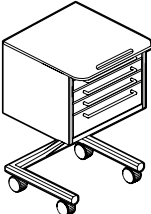
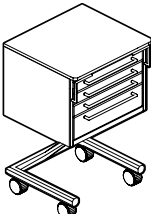

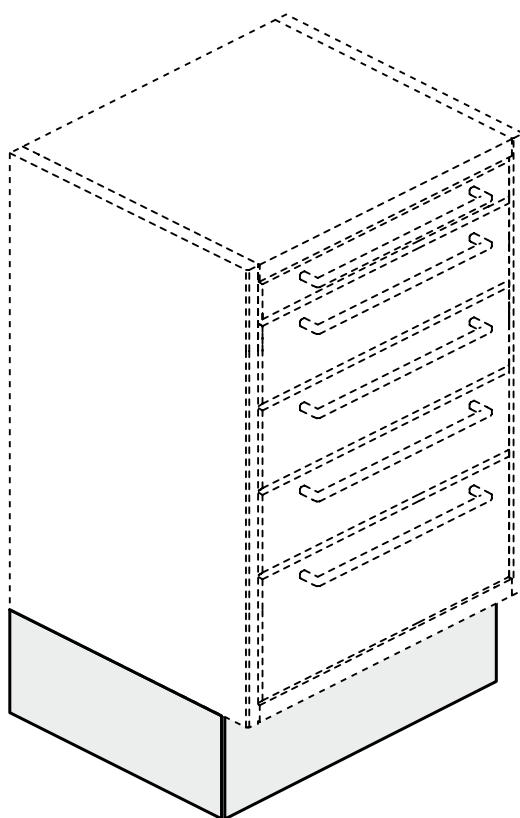
	Descrizione / Description Description / Beschreibung / Descripción	M <sup>3</sup> Kg	Articolo Item / Article Artikel / Artículo
 <p><b>L 502 x P 502 x H 103 mm</b></p>	<p><b>Kit ruote + piano sagomato in vetro</b> Castor set + shaped glass top Kit roues + plan façonné en verre Rollenset + geformte Glasarbeitsplatte Kit de ruedas + encimera perfilada de vidrio</p>	<p>0,05 ----- 10,1</p>	<p>KRV  Extra-chiaro / Extra clear Transparent / Transparent Extra-claro  Satinato / Satin / De poli Satiniert / Satinado</p>
 <p><b>L 502 x P 509 x H 100 mm</b></p>	<p><b>Kit ruote + piano sagomato in stratificato bianco</b> Castor set + shaped white stratified top Kit roues + plan façonné en stratifié blanc Rollenset + geformte Arbeitsplatte aus weißem Schichtstoff Kit de ruedas + encimera perfilada de estratificado blanco</p>	<p>0,05 ----- 5,6</p>	<p>KRS</p>
 <p><b>L 503 x P 435 x H 94 mm</b></p>	<p><b>Kit ruote + piano in vetro sp. 6 mm</b> Castor set + glass top th. 6 mm Kit roues + plan en verre ép. 6 mm Rollenset + Glasarbeitsplatte St. 6 mm Kit de ruedas + encimera de vidrio es. 6 mm</p>	<p>- ----- 4,5</p>	<p>KRL</p>
 <p><b>L 502 x P 502 x H 765 mm</b></p>	<p><b>Modulo su carrello con 3 cassetti A e 1B. Piano sagomato in vetro</b> Movable unit with 4 drawers: 3A and 1B. Shaped glass top Élément mobile avec 4 tiroirs: 3A et 1B. Plan façonné en verre Rollenschränk mit 4 Schubladen: 3A und 1B. Geformte Glasarbeitsplatte Elemento móvil con 4 cajones: 3A y 1B. Encimera perfilada de vidrio</p> <p><b>Bacine/Trays/Intérieurs de tiroir/Einsätze/Bandejas: 1x1A, 1x2A, 1x7A, 1x10B</b></p>	<p>0,30 ----- 34</p>	<p>SC4-V  Extra-chiaro / Extra clear Transparent / Transparent Extra-claro  Satinato / Satin / De poli Satiniert / Satinado</p>
 <p><b>L 502 x P 509 x H 762 mm</b></p>	<p><b>Modulo su carrello con 4 cassetti: 3A e 1B. Piano sagomato in stratificato bianco</b> Movable unit with 4 drawers: 3A and 1B. Shaped white stratified top Module mobile avec 4 tiroirs: 3A et 1B. Plan façonné en stratifié blanc Rollenschränk mit 4 Schubladen: 3A und 1B. Geformte Arbeitsplatte aus weißem Schichtstoff Elemento móvil con 4 cajones: 3A y 1B. Encimera perfilada de estratificado blanco</p> <p><b>Bacine/Trays/Intérieurs de tiroir/Einsätze/Bandejas: 1x1A, 1x2A, 1x7A, 1x10B</b></p>	<p>0,30 ----- 29,5</p>	<p>SC4-S</p>
 <p><b>L 503 x P 435 x H 756 mm</b></p>	<p><b>Modulo su carrello con 4 cassetti: 3A e 1B. Piano vetro sp. 6 mm</b> Movable unit with 4 drawers: 3A and 1B. Glass top th. 6 mm Élément mobile avec 4 tiroirs: 3A et 1B. Plan en verre ép. 6 mm Rollenschränk mit 4 Schubladen: 3A und 1B. Glasarbeitsplatte St. 6 mm Elemento móvil con 4 cajones: 3A y 1B. Encimera de vidrio es. 6 mm</p> <p><b>Bacine/Trays/Intérieurs de tiroir/Einsätze/Bandejas: 1x1A, 1x2A, 1x7A, 1x10B</b></p>	<p>0,25 ----- 28,3</p>	<p>SC4-L</p>

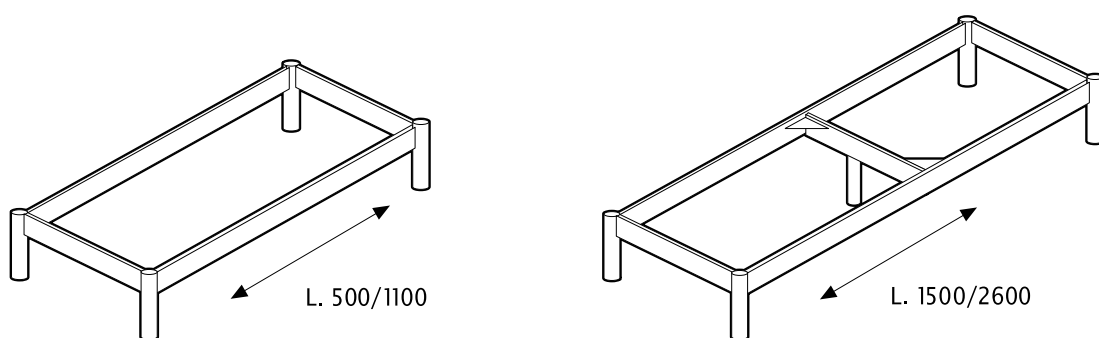

<b>Dimensioni</b> Dimensions / Dimensions Maße / Medidas	<b>Descrizione / Description</b> Description / Beschreibung / Descripción	<b>M<sup>3</sup></b> <b>Kg</b>	<b>Articolo</b> Item / Article Artikel / Artículo
<b>L 605 x P 605 x H 160 mm</b>	<b>Basamento angolare</b> Corner base unit - Base d'angle Ecksockel - Base angular	- ----- 3,5	B01
<b>L 300 x P 390 x H 160 mm</b>	<b>Basamento L 300</b> Base unit L 300 - Base L 300 Sockel L 300 - Base L 300	- ----- 1,5	B02
<b>L 400 x P 390 x H 160 mm</b>	<b>Basamento L 400</b> Base unit L 400 - Base L 400 Sockel L 400 - Base L 400	- ----- 2	B06
<b>L 500 x P 390 x H 160 mm</b>	<b>Basamento L 500</b> Base unit L 500 - Base L 500 Sockel L 500 - Base L 500	- ----- 2,5	B03
<b>L 600 x P 390 x H 160 mm</b>	<b>Basamento L 600</b> Base unit L 600 - Base L 600 Sockel L 600 - Base L 600	- ----- 3	B04
<b>L 1000 x P 390 x H 160 mm</b>	<b>Basamento L 1000</b> Base unit L 1000 - Base L 1000 Sockel L 1000 - Base L 1000	- ----- 4	B05



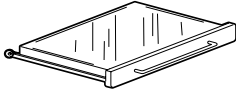
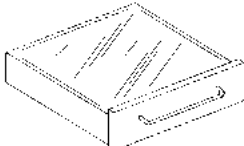

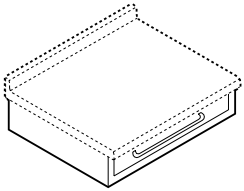
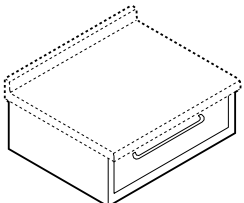
<b>Dimensioni</b> Dimensions / Dimension Maße / Medidas	<b>Descrizione / Description</b> Description / Beschreibung / Descripción	<b>M<sup>3</sup></b> <b>Kg</b>	<b>Articolo</b> Item / Article Artikel / Artículo
<b>L 635 x P 635 x H 160 mm</b>	<b>Supporto angolare con piedini</b> Corner support with feet - Support d'angle avec pieds Eckgestell mit Füßen - Soporte angular con patas	0,10 ----- 5	SR01
<b>L 500 x P 390 x H 160 mm</b>	<b>Supporto L 500 con piedini</b> Support with feet L 500 - Support L 500 avec pieds Gestell L 500 mit Füßen - Soporte con patas L 500	0,05 ----- 4	SR05
<b>L 600 x P 390 x H 160 mm</b>	<b>Supporto L 600 con piedini</b> Support with feet L 600 - Support L 600 avec pieds Gestell L 600 mit Füßen - Soporte con patas L 600	0,05 ----- 4,5	SR06
<b>L 1000 x P 390 x H 160 mm</b>	<b>Supporto L 1000 con piedini</b> Support with feet L 1000 - Support L 1000 avec pieds Gestell L 1000 mit Füßen - Soporte con patas L 1000	0,10 ----- 5	SR10
<b>L 1100 x P 390 x H 160 mm</b>	<b>Supporto L 1100 con piedini</b> Support with feet L 1100 - Support L 1100 avec pieds Gestell L 1100 mit Füßen - Soporte con patas L 1100	0,10 ----- 5,5	SR11
<b>L 1500 x P 390 x H 160 mm</b>	<b>Supporto L 1500 con piedini</b> Support with feet L 1500 - Support L 1500 avec pieds Gestell L 1500 mit Füßen - Soporte con patas L 1500	0,12 ----- 8	SR15
<b>L 1600 x P 390 x H 160 mm</b>	<b>Supporto L 1600 con piedini</b> Support with feet L 1600 - Support L 1600 avec pieds Gestell L 1600 mit Füßen - Soporte con patas L 1600	0,12 ----- 8,5	SR16
<b>L 2000 x P 390 x H 160 mm</b>	<b>Supporto L 2000 con piedini</b> Support with feet L 2000 - Support L 2000 avec pieds Gestell L 2000 mit Füßen - Soporte con patas L 2000	0,16 ----- 10	SR20
<b>L 2100 x P 390 x H 160 mm</b>	<b>Supporto L 2100 con piedini</b> Support with feet L 2100 - Support L 2100 avec pieds Gestell L 2100 mit Füßen - Soporte con patas L 2100	0,16 ----- 10,5	SR21
<b>L 2500 x P 390 x H 160 mm</b>	<b>Supporto L 2500 con piedini</b> Support with feet L 2500 - Support L 2500 avec pieds Gestell L 2500 mit Füßen - Soporte con patas L 2500	0,20 ----- 12,5	SR25
<b>L 2600 x P 390 x H 160 mm</b>	<b>Supporto L 2600 con piedini</b> Support with feet L 2600 - Support L 2600 avec pieds Gestell L 2600 mit Füßen - Soporte con patas L 2600	0,20 ----- 13	SR26

	<b>Descrizione</b> / Description Description / Beschreibung / Descripción	<b>M<sup>3</sup></b> <b>Kg</b>	<b>Articolo</b> Item / Article Artikel / Artículo
	<p><b>Vetro a filo cassetto A</b></p> <p>Glass-top for drawer A</p> <p>Verre installé à fil sur tiroir A</p> <p>Glas bündig mit der Schublade A</p> <p>Tapa vidrio a ras del cajón A</p>	- 3	OFC
	<p><b>Negatoscopio per cassetto B</b></p> <p>Negatoscope for drawer B</p> <p>Négatoscope pour tiroir B</p> <p>Röntgenfilmbetrachter für Schublade B</p> <p>Negatoscopio para cajón B</p>	- 3	CN
	<p><b>Alloggio per micromotore, nel cassetto B, con caviglia e predisposizione per l'aspirazione</b></p> <p>Compartment for micromotor, in drawer B, with peg and setting for suction apparatus</p> <p>Emplacement pour micromoteur, dans le tiroir B, avec cheville et prédisposition pour l'aspiration</p> <p>Schublade B mit Sitz für Mikromotor, Feilkloben und Vorrüstung für Absauganlage</p> <p>Compartimiento para micromotor, en el cajón B, con clavija y predisposición para la aspiración</p>	- 3	CSA
 L 500 x P 460 x H 110 mm	<p><b>Cassettiera monocassetto A</b></p> <p>Single-drawer A unit</p> <p>Module mono-tiroir A</p> <p>Unterbaufähige Schublade A</p> <p>Cajonera monocajón A</p>	- 12	CMA-S
 L 500 x P 460 x H 175 mm	<p><b>Cassettiera monocassetto B</b></p> <p>Single-drawer B unit</p> <p>Module mono-tiroir B</p> <p>Unterbaufähige Schublade B</p> <p>Cajonera monocajón B</p>	- 12	CMB-S

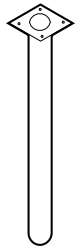
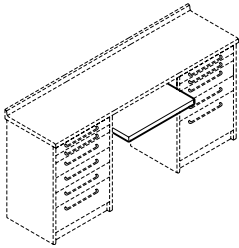
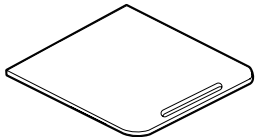
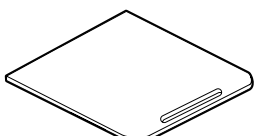
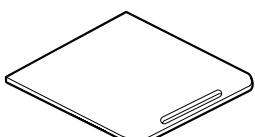

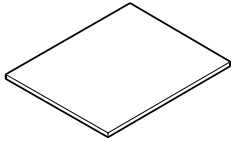
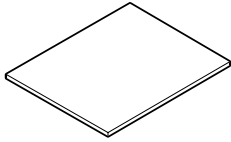
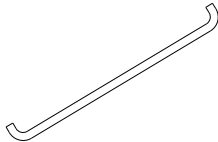
	Descrizione / Description Description / Beschreibung / Descripción	M <sup>3</sup> Kg	Articolo Item / Article Artikel / Artículo
 <p>Ø 60 H min 785 - H max 875 mm</p>	<p><b>Supporto in tubolare per piano</b></p> <p>Tube top bracket</p> <p>Support en tube pour plan</p> <p>Rundrohrbeine für Arbeitsplatte</p> <p>Soporte en tubular para la encimera</p>	-	STP
 <p>L 500 x P 400 x H 30 mm</p>	<p><b>Piano estraibile in laminato per tastiera</b></p> <p>Pull-out laminated top for keyboard</p> <p>Tirette en laminé pour clavier</p> <p>Ausziehbare Platte für Tastatur</p> <p>Estante extraíble de laminado para teclado</p>	-	PPT
 <p>L 502x P 509 x H 12 mm</p>	<p><b>Piano sagomato in Corian® bianco per servomobile</b></p> <p>White Corian® shaped top for movable unit</p> <p>Plan façonné en Corian® blanc pour module mobile</p> <p>Geformte Arbeitsplatte aus weißem Corian® für Rollenschrank</p> <p>Encimera perfilada de Corian® blanco para módulo móvil</p>	-	PSA
 <p>L 502x P 509 x H 12 mm</p>	<p><b>Piano sagomato in stratificato bianco per servomobile</b></p> <p>White stratified shaped top for movable unit</p> <p>Plan façonné en stratifié blanc pour module mobile</p> <p>Geformte Arbeitsplatte aus weißem Schichtstoff für Rollenschrank</p> <p>Encimera perfilada de estratificado blanco para módulo móvil</p>	-	PS06
 <p>L 502 x P 502 x H 15 mm</p>	<p><b>Piano sagomato in vetro per servomobile</b></p> <p>Glass shaped top for movable unit</p> <p>Plan façonné en verre pour module mobile</p> <p>Geformte Glasarbeitsplatte für Rollenschrank</p> <p>Encimera perfilada de vidrio para módulo móvil</p>	-	PSB
		9	<p><b>Extra-chiaro / Extra clear</b> Transparent / Transparent Extra-claro</p> <p><b>Satinato / Satin / De poli</b> Satiniert / Satinado</p>

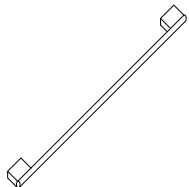
	<b>Descrizione / Description</b> Description / Beschreibung / Descripción	<b>M<sup>3</sup></b> <b>Kg</b>	<b>Articolo</b> Item / Article Artikel / Artículo
	<p><b>Piano in vetro sp. 6 mm per servomobile, solo verde acqua</b></p> <p>Glass top th. 6 mm colour for movable unit, only verde acqua Plan en verre ép. 6 mm pour module mobile, seulement verde acqua Glasarbeitsplatte St. 6 mm für Rollenschrank, nur verde acqua Encimera de vidrio es. 6 mm para módulo móvil, solo verde acqua</p>	- ----- 3,3	POB
<b>L 503 x P 435 x H 6 mm</b>			
	<p><b>Piano in vetro sp. 10 mm per servomobile</b></p> <p>Glass top th. 10 mm colour for movable unit Plan en verre ép. 10 mm pour module mobile Glasarbeitsplatte St. 10 mm für Rollenschrank Encimera de vidrio es. 10 mm para módulo móvil</p>	- ----- 5,5	PSB1
<b>L 503 x P 435 x H 10 mm</b>			<p><b>Extra-chiaro / Extra clear</b> Transparent / Transparent Extra-claro</p> <p><b>Satinato / Satin / De poli</b> Satinert / Satinado</p>
	<p><b>Maniglia Start alluminio naturale o verniciata</b></p> <p>Start handle: aluminium or painted Poignée Start: aluminium ou peint Griff Start: Aluminium oder lackiert Tirador Start: aluminio o pintado</p>	- ----- -	MABF
	<p><b>Maniglia traino alluminio naturale o verniciata</b></p> <p>Pull handle: aluminium or painted Poignée d'angle: aluminium ou peint Ziehen Griff: Aluminium oder lackiert Tirador: aluminio o pintado</p>	- ----- -	MABM
	<p><b>Maniglia FAM in alluminio</b></p> <p>Aluminium handle FAM Poignée en aluminium FAM FAM Aluminiumgriff Tirador FAM de aluminio</p>	- ----- -	MA3

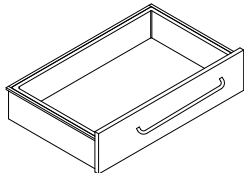
Descrizione / Description Description / Beschreibung / Descripción	M <sup>3</sup> Kg	Articolo Item / Article Artikel / Artículo
 <p><b>CASSETTO START</b>                      Drawer Start                      Tiroir Start                      Schublade Start                      Cajón Start</p>	A) H 60 ----- 3	CAA05
	B) H 121 ----- 4	CAB05
	C) H 182 ----- 4,3	CAC05
	D) H 245 ----- 4,7	CAE08

## Composizione Lineare nelle soluzioni \_B / \_S

Straight composition in the solutions \_B / \_S

Composition linéaire dans les solutions \_B / \_S

Lineare Zusammenstellung in den Ausführungen \_B / \_S

Composición lineal en las soluciones \_B / \_S

### Start\_B

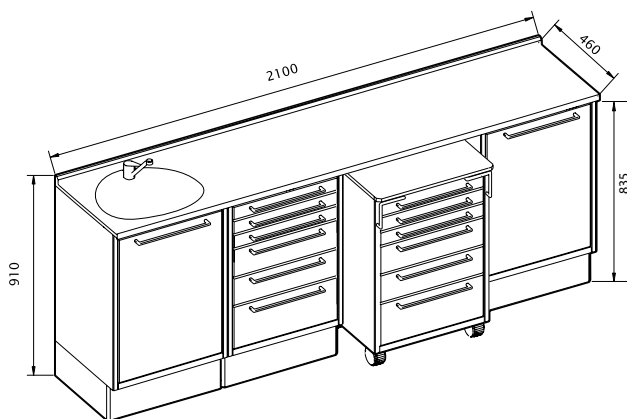

SL-I\_B+KEL+SF6\_B+SF6+KR...+SFP-5\_B+3 B03+TOP...+V...+RB...

### Start\_S

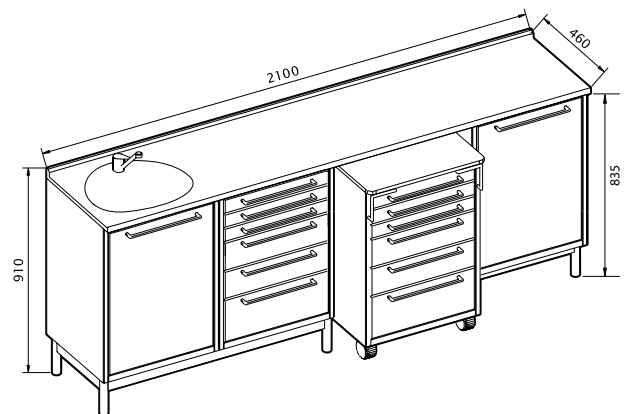

SL-I\_S+KEL+SF6\_S+SF6+KR...+SFP-5\_S+SR10+SR05+TOP...+V...+RB...

1	<p><b>Piano laminato VCF+RB2</b> Laminated top Plan en laminé Laminatarbeitsplatte Encimera de laminado</p> <p><b>L 2100 x P 460 x H 910 mm</b></p>	<p><b>KRV</b></p> <hr/> <p><b>KRL</b></p>
2	<p><b>Piano stratificato bianco VAS+RB3</b> White stratified top Plan en stratifié blanc Arbeitsplatte aus weißem Schichtstoff Encimera de estratificado blanco</p> <p><b>L 2100 x P 505 x H 847 mm</b></p>	<p><b>KRS</b></p>
3	<p><b>Piano vetro sp.15mm - colori standard VVI/15+RB2</b> Glass top th. 15mm - standard colors Plan en verre ép. 15mm - couleurs standard Glasarbeitsplatte St. 15mm - Standard Farben Encimera de vidrio es. 15mm - colores estándar</p> <p><b>L 2100 x P 505 x H 850 mm</b></p>	<p><b>KRV</b></p>

## Composizione Angolare nelle soluzioni \_B / \_S

Corner composition in the solutions \_B / \_S

Composition d'angle dans les solutions \_B / \_S

Eckzusammenstellung in den Ausführungen \_B / \_S

Composición angular en las soluciones \_B / \_S

### Start\_B

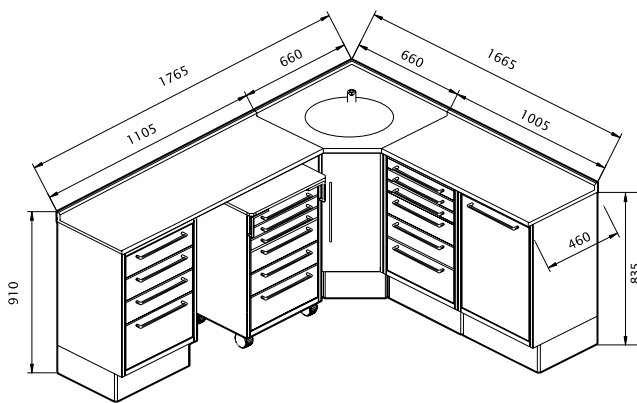

SF3C\_B+SF6+KR...+SLA-I\_B+KEL+SF6\_B+SFP-5\_B+B01+3 B03+TOP...+V...+RB...



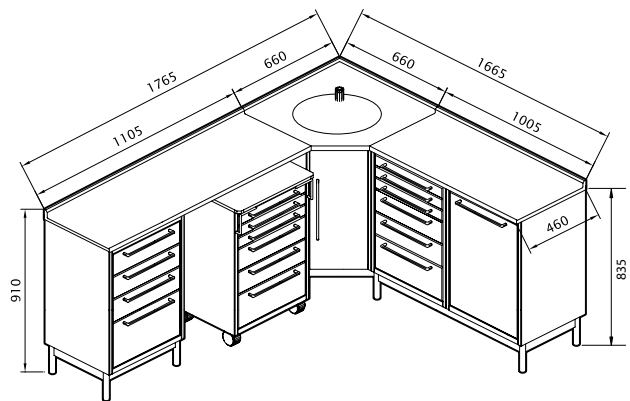

### Start\_S

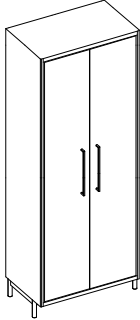
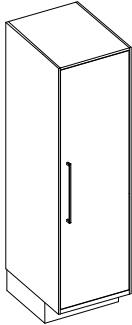
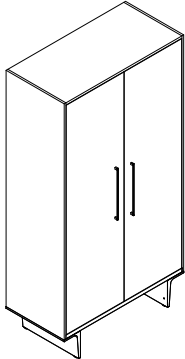

SF3C\_S+SF6+KR...+SLA-I\_S+KEL+SF6\_S+SFP-5\_S+SR05+SR01+SR10+TOP...+V...+RB...

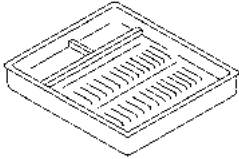
1	<b>Piano laminato VCF+RB2</b> Laminated top Plan en laminé Laminatarbeitsplatte Encimera de laminado	<b>KRV</b>
	<b>L 1765 x 1665 x P 460 x H 910 mm</b>	<b>KRL</b>
2	<b>Piano stratificato bianco VAS+RB3</b> White stratified top Plan en stratifié blanc Arbeitsplatte aus weißem Schichtstoff Encimera de estratificado blanco	<b>KRS</b>
	<b>L 1810 x 1710 x P 505 x H 847 mm</b>	
3	<b>Piano vetro sp.15mm - colori standard VIV+RB2</b> Glass top th. 15mm - standard colors Plan en verre ép. 15mm - couleurs standard Glasarbeitsplatte St. 15mm - Standard Farben Encimera de vidrio es. 15mm - colores estándar	<b>KRV</b>
	<b>L 1810 x 1710 x P 505 x H 850 mm</b>	

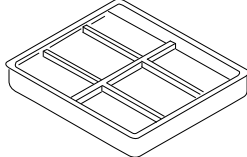
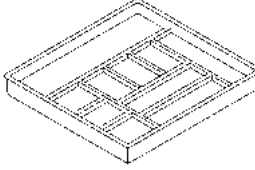
	Descrizione / Description Description / Beschreibung / Descripción	M <sup>3</sup> Kg	Articolo Item / Article Artikel / Artículo
 <p><b>L 500 x P 500 x H 1915 mm</b></p>	<p><b>START</b> <b>Armadio con basamento o supporto, anta in metallo e 5 ripiani interni</b></p> <p>Cabinet with base or support with feet, with door and 5 interior shelves</p> <p>Armoire avec base ou support avec pieds, avec porte et 5 étagères internes</p> <p>Schrank mit Sockel oder Gestell mit Füßen, mit Tür und 5 Einlegeböden</p> <p>Armario con base o soporte con patas, con puerta y 5 estantes interiores</p>	0,70 ----- 45	ARB05
		0,70 ----- 45	ARS05
 <p><b>L 1000 x P 500 x H 1915 mm</b></p>	<p><b>START</b> <b>Armadio con basamento o supporto, 2 ante in metallo e 5 ripiani interni</b></p> <p>Cabinet with base or support with feet, with 2 doors and 5 interior shelves</p> <p>Armoire avec base ou support avec pieds, avec 2 portes et 5 étagères internes</p> <p>Schrank mit Sockel oder Gestell mit Füßen, mit 2 Türen und 5 Einlegeböden</p> <p>Armario con base o soporte con patas, con 2 puertas y 5 estantes interiores</p>	1,25 ----- 65	ARB10
		1,25 ----- 65	ARS10
 <p><b>L 530 x P 500 x H 1915 mm</b></p>	<p><b>VELA</b> <b>Armadio con basamento, fianchi , coperchio, anta in metallo e 5 ripiani interni</b></p> <p>Cabinet with base, lateral sides, upper cover, door and 5 interior shelves</p> <p>Armoire avec base, panneaux latéraux, capot supérieur, porte et 5 étagères internes</p> <p>Schrank mit Sockel, Seitenwände, Deckel, Tür und 5 Einlegeböden</p> <p>Armario con base, paneles lateral, tapa superior, puerta y 5 estantes interiores</p>	0,70 ----- 74	ARV05B
		0,70 ----- 74	ARV05B
 <p><b>L 1030 P 500 x H 1915 mm</b></p>	<p><b>VELA</b> <b>Armadio con basamento o supporto a pavimento, fianchi, coperchio, 2 ante in metallo e 5 ripiani interni</b></p> <p>Cabinet with base or floor support, lateral sides, upper cover, 2 doors and 5 interior shelves</p> <p>Armoire avec base ou support au sol, panneaux latéraux, capot supérieur, 2 portes et 5 étagères internes</p> <p>Schrank mit Sockel oder Bodengestell, Seitenwände, Deckel, 2 Türen und 5 Einlegeböden</p> <p>Armario con base o soporte de pie, paneles lateral, tapa superior, 2 puertas y 5 estantes interiores</p>	1,25 ----- 90	ARV10B
		1,25 ----- 100	ARV10S

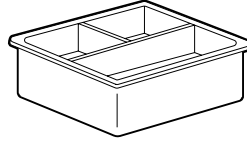
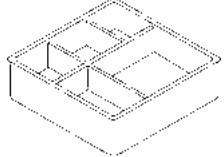
	Descrizione / Description Description / Beschreibung / Descripción	M <sup>3</sup> Kg	Articolo Item / Article Artikel / Artículo
 <b>L 405 x P 330 x H 35 mm</b>	<b>BACINELLA con rastrelliera portastrumenti, per cassetto A</b> Instrument compartment drawer tray, for drawer A Intérieur de tiroir porte-instruments, pour tiroir A Einsatz mit Instrumentenhalter, für Schublade A Bandeja porta instrumentos, para cajón A	- 0,4	1A
 <b>L 405 x P 330 x H 35 mm</b>	<b>BACINELLA piana, per cassetto A</b> Flat drawer tray, for drawer A Intérieur de tiroir bas, pour tiroir A Niedriger Einsatz, für Schublade A Bandeja plana, para cajón A	- 0,4	2A
 <b>L 405 x P 330 x H 35 mm</b>	<b>BACINELLA a 6 settori, per cassetto A</b> Drawer tray with 6 compartments, for drawer A Intérieur de tiroir à 6 secteurs, pour tiroir A 6-Fächern Einsatz, für Schublade A Bandeja con 6 sectores, para cajón A	- 0,4	3A
 <b>L 405 x P 330 x H 35 mm</b>	<b>BACINELLA a 10 settori, per cassetto A</b> Drawer tray with 10 compartments, for drawer A Intérieur de tiroir à 10 secteurs, pour tiroir A 10-Fächern Einsatz, für Schublade A Bandeja con 10 sectores, para cajón A	- 0,4	7A
 <b>L 405 x P 330 x H 80 mm</b>	<b>BACINELLA piana, per cassetto B</b> Flat drawer tray, for drawer B Intérieur de tiroir bas, pour tiroir B Niedriger Einsatz, für Schublade B Bandeja plana, para cajón B	- 0,5	9B
 <b>L 405 x P 330 x H 80 mm</b>	<b>BACINELLA a 3 settori, per cassetto B</b> Drawer tray with 3 compartment, for drawer B Intérieur de tiroir à 3 secteurs, pour tiroir B 3-Fächern Einsatz, für Schublade B Bandeja con 3 sectores, para cajón B	- 0,5	10B
 <b>L 405 x P 330 x H 80 mm</b>	<b>BACINELLA a 5 settori, per cassetto B</b> Drawer tray with 5 compartment, for drawer B Intérieur de tiroir à 5 secteurs, pour tiroir B 5-Fächern Einsatz, für Schublade B Bandeja con 5 sectores, para cajón B	- 0,5	11B

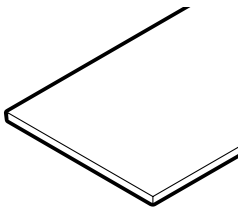
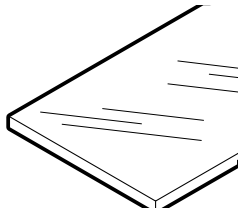
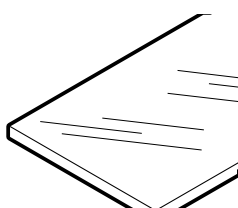
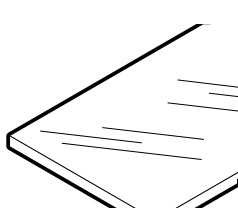
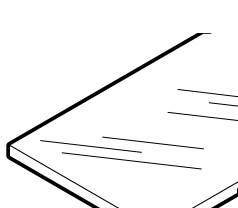
	<b>Descrizione / Description</b> Description / Beschreibung / Descripción	<b>M<sup>3</sup></b> <b>Kg</b>	<b>Articolo</b> Item / Article Artikel / Artículo
 <p><b>P 455 x H 12 mm</b> <b>P 505 x H 12 mm</b> <b>P 600 x H 12 mm</b></p>	<p><b>Piano in Corian® bianco: al metro lineare</b> White Corian® top: per meter Plan en Corian® blanc: au mètre Weiß Corian® Arbeitsplatte: je Meter Encimera de Corian® blanco: al m.</p>	-	CA (P 455 mm)
		-	CB (P 505 mm)
		-	CD (P 600 mm)
 <p><b>P 455 x H 12 mm</b> <b>P 505 x H 12 mm</b> <b>P 600 x H 12 mm</b></p>	<p><b>Piano in vetro: al metro lineare</b> Glass top: per meter Plan en verre: au mètre Glasarbeitsplatte: je Meter Encimera de vidrio: al m.</p>	-	VA (P 455 mm)
		-	VB (P 505 mm)
		-	VD (P 600 mm)
 <p><b>P 455 x H 12 mm</b> <b>P 505 x H 12 mm</b> <b>P 600 x H 12 mm</b></p>	<p><b>Piano in vetro satinato: al metro lineare</b> Glass top satin: per meter Plan en verre dépoli: au mètre Satinierter Glasarbeitsplatte: je Meter Encimera de vidrio satinado: al m.</p>	-	XA (P 455 mm)
		-	XB (P 505 mm)
		-	XD (P 600 mm)
 <p><b>P 455 x H 12 mm</b> <b>P 505 x H 12 mm</b> <b>P 600 x H 12 mm</b></p>	<p><b>Piano in vetro extra-chiaro: al metro lineare</b> Extra clear glass top: per meter Plan en verre transparent: au mètre Transparente Glasarbeitsplatte: je Meter Encimera de vidrio transparente: al m.</p>	-	YA (P 455 mm)
		-	YB (P 505 mm)
		-	YD (P 600 mm)
 <p><b>P 455 x H 12 mm</b> <b>P 505 x H 12 mm</b> <b>P 600 x H 12 mm</b></p>	<p><b>Piano in vetro extra-chiaro satinato: al metro lineare</b> Extra-clear glass top satin: per meter Plan en verre transparent dépoli: au mètre Transparente satinierter Glasarbeitsplatte: je Meter Encimera de vidrio transparente satinado: al m.</p>	-	ZA (P 455 mm)
		-	ZB (P 505 mm)
		-	ZD (P 600 mm)

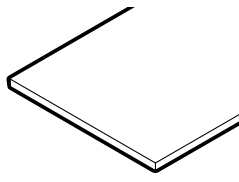
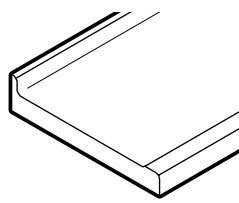
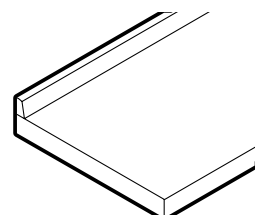
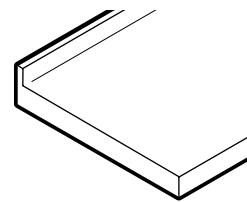
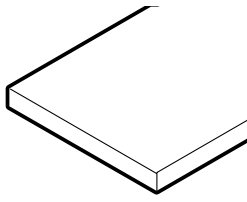
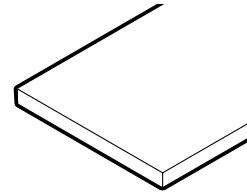

	<b>Descrizione / Description</b> Description / Beschreibung / Descripción	<b>M<sup>3</sup></b> <b>Kg</b>	<b>Articolo</b> Item / Article Artikel / Artículo
 <b>P 455 x H 12 mm</b> <b>P 505 x H 12 mm</b> <b>P 600 x H 12 mm</b>	<b>Piano in stratificato bianco: al metro lineare</b> White stratified top: per meter Plan en stratifié blanc: au mètre Weiß Schichtstoffarbeitsplatte: je Meter Encimera de estratificado blanco: al m.	- 8,6	SA (P 455 mm)
		- 9,6	SB (P 505 mm)
		- 11,4	SD (P 600 mm)
 <b>P 460 x H 30 mm</b> <b>P 520 x H 30 mm</b>	<b>Piano in laminato con alzatina incorporata H 45 mm: al metro lineare</b> Laminated top with rear trim H 45 mm: per meter Plan en laminé avec dossier H 45 mm: au mètre Laminatarbeitsplatte mit Aufkantung H 45 mm: je Meter Encimera de laminado con elevación H 45 mm: al m.	- 10	BA (P 460 mm)
		- 11	BC (P 520 mm)
 <b>P 460 x H 30 mm</b> <b>P 520 x H 30 mm</b> <b>P 600 x H 30 mm</b>	<b>Piano in laminato con alzatina applicata ALB H 40 mm: al metro lineare</b> Laminated top with applied rear trim ALB H 40 mm: per meter Plan en laminé avec dossier appliqué ALB H 40 mm: au mètre Laminatarbeitsplatte mit aufgeklebter Aufkantung ALB H 40 mm: je Meter Encimera de laminado con elevación aplicado ALB H 40 mm: al m.	- 10	TA (P 460 mm)
		- 11	TC (P 520 mm)
		- 12	TD (P 600 mm)
 <b>P 520 x H 30 mm</b> <b>P 600 x H 30 mm</b>	<b>Piano in acciaio inox con alzatina incorporata H 70 mm: al metro lineare</b> Stainless steel top with rear trim H 70 mm: per meter Plan en acier inox avec dossier H 70 mm: au mètre Edelstahlarbeitsplatte mit Aufkantung H 70 mm: je Meter Encimera de acero inox con elevación H 70 mm: al m.	- 14	HC (P 520 mm)
		- 18	HD (P 600 mm)
 <b>P 520 x H 30 mm</b> <b>P 600 x H 30 mm</b>	<b>Piano in acciaio inox senza alzatina: al metro lineare</b> Stainless steel top: per meter Plan en acier inox: au mètre Edelstahlarbeitsplatte: je Meter Encimera de acero inox: al m.	- 13	IC (P 520 mm)
		- 15	ID (P 600 mm)
 <b>P 455 x H 20 mm</b> <b>P 505 x H 20 mm</b> <b>P 600 x H 20 mm</b>	<b>Piano in laminato Fenix®: al metro lineare</b> Fenix® - laminate worktop: per meter Plan de travail en laminé Fenix®: au mètre Arbeitsplatte aus Laminat Fenix®: je Meter Encimera de laminado Fenix®: al m.	- 6	FA (P 455 mm)
		- 6,4	FB (P 505 mm)
		- 7,6	FD (P 600 mm)

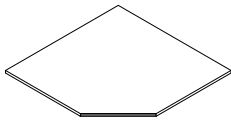
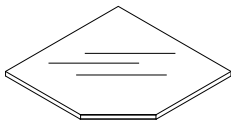
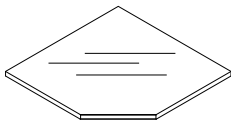
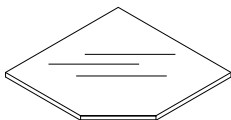
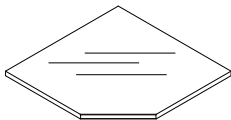
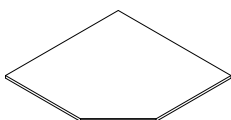
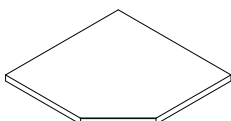
	<b>Descrizione / Description</b> Description / Beschreibung / Descripción	<b>M<sup>3</sup></b> <b>Kg</b>	<b>Articolo</b> Item / Article Artikel / Artículo
  <b>L 705 x P 705 x H 12 mm</b> <b>L 800 x P 800 x H 12 mm</b>	<b>Piano angolare in Corian® bianco</b> White Corian® top for corner units Plan en Corian® blanc pour modules d'angle Weiß Corian® Arbeitsplatte für Eckschränke Encimera de Corian® blanco para módulos angulares	- ----- 10,3	CBA (P 705 mm)
		- ----- 13,3	CDA (P 800 mm)
  <b>L 705 x P 705 x H 15 mm</b> <b>L 800 x P 800 x H 15 mm</b>	<b>Piano angolare in vetro</b> Glass top for corner units Plan en verre pour modules d'angle Glasarbeitsplatte für Eckschränke Encimera de vidrio para módulos angulares	- ----- 18	VBA
		- ----- 18	VDA
  <b>L 705 x P 705 x H 15 mm</b> <b>L 800 x P 800 x H 15 mm</b>	<b>Piano angolare in vetro satinato</b> Glass top satin for corner units Plan en verre dépoli pour modules d'angle Satinierte Glasarbeitsplatte für Eckschränke Encimera de vidrio satinado para módulos angulares	- ----- 18	XBA
		- ----- 18	XDA
  <b>L 705 x P 705 x H 15 mm</b> <b>L 800 x P 800 x H 15 mm</b>	<b>Piano angolare in vetro extra-chiaro</b> Extra-clear glass top for corner units Plan en verre transparent pour modules d'angles Transparente Glasarbeitsplatte für Eckschränke Encimera de vidrio transparente para módulos angulares	- ----- 18	YBA
		- ----- 18	YDA
  <b>L 705 x P 705 x H 15 mm</b> <b>L 800 x P 800 x H 15 mm</b>	<b>Piano angolare in vetro extra-chiaro satinato</b> Extra-clear glass top satin for corner units Plan en verre transparent dépoli pour modules d'angles Transparente satinierte Glasarbeitsplatte für Eckschränke Encimera de vidrio trasparente satinado para módulos angulares	- ----- 18	ZBA
		- ----- 18	ZDA
  <b>L 705 x P 705 x H 12 mm</b> <b>L 800 x P 800 x H 12 mm</b>	<b>Piano angolare in stratificato bianco</b> White stratified top for corner units Plan en stratifié blanc pour modules d'angles Weiß Schichtstoffarbeitsplatte für Eckschränke Encimera de estratificado blanco para módulos angulares	- ----- 9	SBA (P 705 mm)
		- ----- 11,8	SDA (P 800 mm)
  <b>L 705 x P 705 x H 20 mm</b> <b>L 755 x P 755 x H 20 mm</b> <b>L 850 x P 850 x H 20 mm</b>	<b>Piano angolare in laminato Fenix®</b> White laminate top Fenix® for corner units Plan en laminé blanc Fenix® pour modules d'angles Weiße Laminatarbeitsplatte Fenix® für Eckschränke Encimera de laminado blanco Fenix® para módulos angulares	- ----- 6	FAV (P 705 mm)
		- ----- 7	FBV (P 755 mm)
		- ----- 9	FDV (P 850 mm)

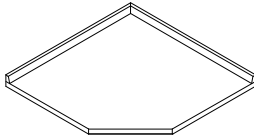
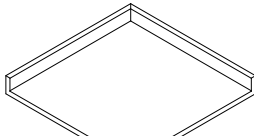
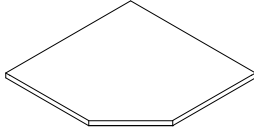
		<b>Descrizione / Description</b> Description / Beschreibung / Descripción	<b>M<sup>3</sup></b> <b>Kg</b>	<b>Articolo</b> Item / Article Artikel / Artículo
 <p><b>L 660 x P 660 x H 30 mm</b> <b>L 720 x P 720 x H 30 mm</b> <b>L 800 x P 800 x H 30 mm</b></p>	<p><b>Piano angolare in laminato con alzatina applicata ALB H 40 mm</b></p> <p>Laminated top with applied rear trim ALB H 40 mm Plan en laminé avec dossier appliqué ALB H 40 mm Laminatarbeitsplatte mit aufgeklebter Aufkantung ALB H 40 mm Encimera de laminado con elevación aplicado ALB H 40 mm</p>	- 8,5	TAA (P 660 mm)	
		- 10	TCA (P 720 mm)	
		- 12	TDA (P 800 mm)	
 <p><b>L 720 x P 720 x H 30 mm</b> <b>L 800 x P 800 x H 30 mm</b></p>	<p><b>Piano angolare in acciaio inox con alzatina incorporata H 70 mm</b></p> <p>Stainless steel top with rear trim H 70 mm Plan en acier inox avec dossier H 70 mm Edelstahlarbeitsplatte mit Aufkantung H 70 mm Encimera de acero inox con elevación H 70 mm</p>	- 13	HCA (P 720 mm)	
		- 16	HDA (P 800 mm)	
 <p><b>L 720 x P 720 x H 30 mm</b> <b>L 800 x P 800 x H 30 mm</b></p>	<p><b>Piano angolare in acciaio inox senza alzatina</b></p> <p>Stainless steel top Plan en acier inox Edelstahlarbeitsplatte Encimera de acero inox</p>	- 12	ICA (P 720 mm)	
		- 14,8	IDA (P 800 mm)	

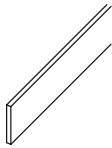
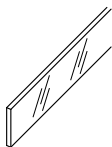
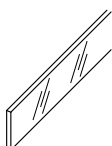
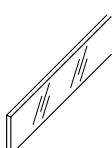
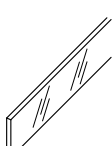
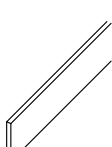
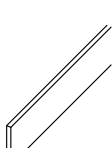
	Descrizione / Description Description / Beschreibung / Descripción	M <sup>3</sup> Kg	Articolo Item / Article Artikel / Artículo
 SP 12 x H 80 mm SP 12 x H 12 mm	<b>Alzatina in Corian® bianco: al metro lineare</b> White Corian® splashback: per meter Dosseret en Corian® blanc: au mètre Weiß Corian® Aufkantung: je Meter Alzada de Corian® blanco: al m.	- 1,5	AC08 (H 80 mm)
		- 0,3	AC01 (H 12 mm)
 SP 15 x H 80 mm SP 15 x H 100 mm	<b>Alzatina in vetro: al metro lineare</b> Glass splashback: per meter Dosseret en verre: au mètre Glasaufkantung: je Meter Alzada de vidrio: al m.	- 3	AV08 (H 80 mm)
		- 3,8	AV10 (H 100 mm)
 SP 15 x H 80 mm SP 15 x H 100 mm	<b>Alzatina in vetro satinato: al metro lineare</b> Glass splashback satin: per meter Dosseret en verre dépoli: au mètre Satinierte Glasaufkantung: je Meter Alzada de vidrio satinado: al m.	- 3	AX08 (H 80 mm)
		- 3,8	AX10 (H 100 mm)
 SP 15 x H 80 mm SP 15 x H 100 mm	<b>Alzatina in vetro extra-chiaro: al metro lineare</b> Extra-clear glass splashback: per meter Dosseret en verre transparent: au mètre Transparente Glasaufkantung: e Meter Alzada de vidrio transparente: al m.	- 3	AY08 (H 80 mm)
		- 3,8	AY10 (H 100 mm)
 SP 15 x H 80 mm SP 15 x H 100 mm	<b>Alzatina in vetro extra-chiaro satinato: al metro lineare</b> Extra-clear glass splashback satin: per meter Dosseret en verre transparent dépoli: au mètre Transparente satinierte Glasaufkantung: e Meter Alzada de vidrio transparente satinado: al m.	- 3	AZ08 (H 80 mm)
		- 3,8	AZ10 (H 100 mm)
 SP 12 x H 80 mm SP 12 x H 100 mm	<b>Alzatina in stratificato bianco: al metro lineare</b> White stratified splashback: per meter Dosseret en stratifié blanc: au mètre Weiß Schichtstoffaufkantung: je Meter Alzada de estratificado blanco: al m.	- 1,5	AS08 (H 80 mm)
		- 1,8	AS10 (H 100 mm)
 SP 20 x H 80 mm	<b>Alzatina in laminato Fenix®: al metro lineare</b> Splashback laminate Fenix®: per meter Dosseret en laminè Fenix®: au mètre Aufkantung aus laminat Fenix®: je Meter Alzada de laminato Fenix®: al m.	- 1	AF08 (H 80 mm)

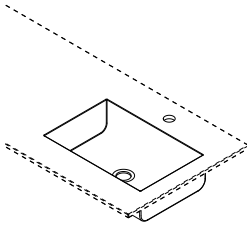
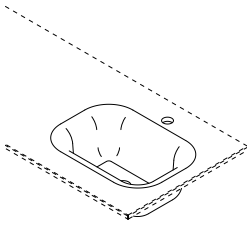
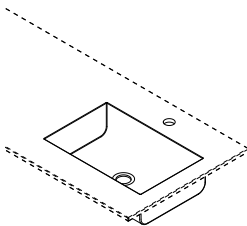
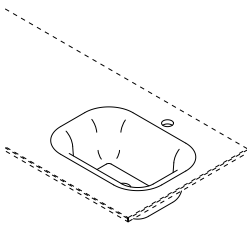
	<b>Descrizione / Description</b> Description / Beschreibung / Descripción	<b>M<sup>3</sup></b> <b>Kg</b>	<b>Articolo</b> Item / Article Artikel / Artículo
 <p><b>L 400 x P 260 x H 110 mm</b></p>	<p><b>Lavello integrato in Corian®</b> Integrated Corian® sink Evier intégré en Corian® Integrierte Waschbecken aus Corian® Lavabo integrado de Corian®</p>		VIC
 <p><b>L 400 x P 300 x H 130 mm</b></p>	<p><b>Lavello termoformato in Corian®</b> Integrated thermoformed Corian® sink Evier intégré thermoformé en Corian® Integriertes tiefgezogenes Waschbecken aus Corian® Lavabo integrado termoformato de Corian®</p>		VTC
 <p><b>L 400 x P 270 x H 195 mm</b></p>	<p><b>Lavello sottopiano in acciaio inox, per piani in Corian® e stratificato</b> Undermont stainless steel sink, for Corian® and stratified top Evier en inox, pour plans en Corian® et stratifié Unterbauedelstahlwaschbecken, für Arbeitsplatte aus Corian® und Schichtstoff Lavabo bajo encimera de acero para encimeras de Corian® y estratificado</p>		VFA
 <p><b>L 400 x P 300 x H 130 mm</b></p>	<p><b>Lavello integrato in vetro</b> Integrated glass sink Evier intégré en verre Integriertes, tiefgezogenes Glaswaschbecken Lavabo integrado de vidrio</p> <p><b>NB: piani lineari L 2800 mm max. / Straight tops L 2800 mm max. / Plans linéaires L 2800 mm max. / Gerade Arbeitsplatte L 2800 mm max. / Encimera lineal L 2800 mm max.</b></p>		VIV

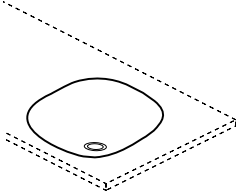
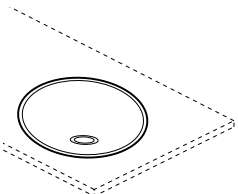
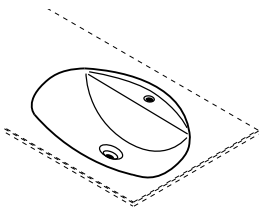
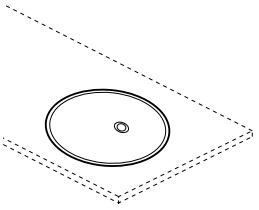
	Descrizione / Description Description / Beschreibung / Descripción	M <sup>3</sup> Kg	Articolo Item / Article Artikel / Artículo
	<p><b>Lavello integrato in vetro (NO satinato / NO angolare)</b> Integrated glass sink (NOT satin / NOT corner) Evier intégré en verre (PAS dépoli / PAS d'angle) Integrierte Glaswaschbecken (NICHT satiniert / NICHT Ecke) Lavabo integrado de vidrio (NO satinado / NO angular)</p> <p><b>NB: piani lineari L 2100 mm max. (solo all'estremità sx o dx del piano) /</b> Straight tops L 2100 mm max. (only at the right or left end of the top) Plans linéaires L 2100 mm max. (uniquement à l'extrémité gauche ou droite du plan) Gerade Arbeitsplatte L 2100 mm max. (nur am linken oder rechten Ende der Arbeitsplatte) Encimera lineal L 2100 mm max. (sólo en el extremo izdo. o dcho. de la encimera)</p>		VI
L 320 x P 320 mm			
	<p><b>Lavello a semisfera in acciaio inox sopra piano</b> Top mounted stainless steel sink Evier en inox sur plan Aufgesetztes Edelstahlwaschbecken Lavabo de acero sobre encimera</p> <p><b>NB: si consiglia il rubinetto RB3 / mixer RB3 suggested / robinet RB3 conseillé /</b> Wasserhahn RB3 empfohlen / se aconseja el grifo RB3</p>	- 1	VAS
Ø 340 mm - H 160 mm			
	<p><b>Lavello in ceramica a filo piano</b> Flush ceramic bowl Evier porcelaine collée sous le plan Porzellanwaschbecken bündig mit der Arbeitsplatte Lavabo de cerámica a ras de la encimera</p>		
	<b>Laminato</b> / Laminato / Laminé / Laminat / Laminado	- 7,2	VCF
	<b>Stratificato</b> / Stratified / Stratifié / Schichtstoff / Estratificado	- 7,2	VCS
L 455 x P 405 mm			
	<p><b>Lavello in acciaio smaltato</b> Enamel steel sink Evier en acier inox émaillé Aufgesetztes emailiertes Stahl-Waschbecken Lavabo de acero esmaltado</p>	- 1	VSS
Ø 340 mm - H 160 mm			

**Descrizione / Description**  
Description / Beschreibung / Descripción

**M<sup>3</sup>**  
**Kg**

**Articolo**  
Item / Article  
Artikel / Artículo

### STERIL CENTER (per piani prof. 505 - 520 - 600 mm)

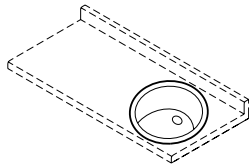

#### Lavello circolare in acciaio inox sopra piano (o sottopiano per piani in Corian® e stratificato)

Top mounted stainless steel sink  
(or undermount for Corian® and stratified top)  
Evier en inox sur plan  
(ou collée sous le plan pour plans en Corian® et stratifié)  
Aufgesetztes Edelstahlwaschbecken  
(oder unterbau montiert für Arbeitsplatte aus Corian® und Schichtstoff)  
Lavabo de acero sobre encimera  
(o bajo encimera para encimeras de Corian® o estratificado)

Ø 380 - H 180 mm

-  
1

V1S

### STERIL CENTER (per piani prof. 600 mm)

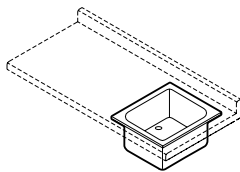

#### Lavello rettangolare in acciaio inox sopra piano

Top mounted stainless steel sink  
Evier en inox sur plan  
Aufgesetztes Edelstahlwaschbecken  
Lavabo de acero sobre encimera

L 360 x P 360 x H 170 mm

-  
2,5

V2S

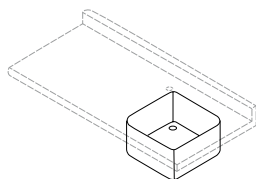

#### Lavello rettangolare in acciaio inox a filo piano (per piani in Corian® e stratificato)

Stainless steel sink (for Corian® and stratified top)  
Evier en inox collée sous le plan  
(pour plans en Corian® et stratifié)  
Edelstahlwaschbecken bündig mit der Arbeitsplatte  
(für Arbeitsplatte aus Corian® und Schichtstoff)  
Lavabo de acero a ras de la encimera  
(para encimeras de Corian® o estratificado)

L 340 x P 400 x H 200 mm

-  
4,5

V2SF

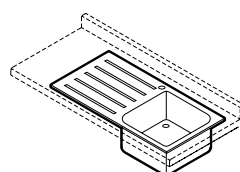

#### Lavello in acciaio inox e sgocciolatoio da incasso

Stainless steel sink with draining board  
Evier en inox avec égouttoir  
Edelstahlwaschbecken mit Abtropfblech  
Lavabo de acero con escurridor

L 860 x P 500 x H 170 mm

-  
3,5

V3S

**Descrizione / Description**  
Description / Beschreibung / Descripción

**M<sup>3</sup>**  
**Kg**

**Articolo**  
Item / Article  
Artikel / Artículo

**Per lo STUDIO / For DENTAL OFFICE /- Pour le CABINET / Für PRAXIS / Por el ESTUDIO**

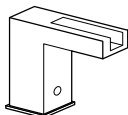

**Rubinetto "a cascata" con fotocellula**

Mixer "a cascata" with photoelectric cell  
Robinet électronique "a cascata" à photocellule  
Elektronische Wasserhahn "a cascata" mit Fotozelle  
Grifo "a cascata" con fotocélula

-  
4      RB8

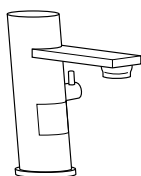

**Rubinetto con fotocellula**

Mixer with photoelectric cell  
Robinet électronique à photocellule  
Elektronische Wasserhahn mit Fotozelle  
Grifo con fotocélula

-  
3      RB7

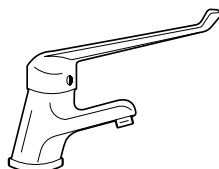

**Rubinetto cromato a leva lunga**

Chromed mixer with long lever  
Robinet chromé à levier long  
Verchromte Wasserhahn mit langem Hebel  
Grifo cromado con palanca larga

-  
1,5      RB2

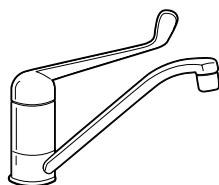

**Rubinetto cromato con collo lungo e leva lunga**

Chromed mixer with long neck and long lever  
Robinet chromé à col long et levier long  
Verchromte Langrohr- und Langhebel-Wasserhahn  
Grifo cromado con caño largo y palanca larga

-  
1,5      RB3



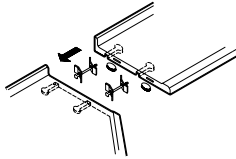
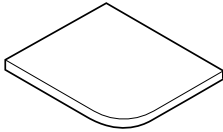
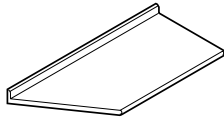
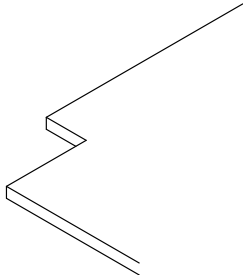

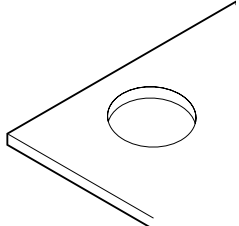
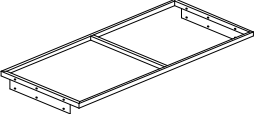
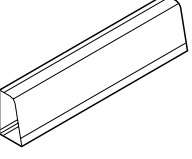
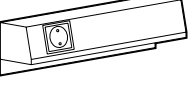
	<b>Descrizione / Description</b> Description / Beschreibung / Descripción	<b>Articolo</b> Item / Article Artikel / Artículo
	<b>Set collegamento 2 piani laminato / fenix</b> Worktop-connection set Set pour la liaison de 2 plans de travail Set für Zusammenbau von Arbeitsplatten Juego para la unión de las 2 encimeras	
	<b>Laminato - Laminato Fenix®</b> Laminate - Laminato Fenix® / Laminé - Laminé Fenix® Laminat - Laminat Fenix® / Laminado - Laminado Fenix®	SCP
	<b>Acciaio inox (30 mm) / Stainless steel (30 mm) / Acier Inox (30 mm) / Edelstahl (30 mm) / Acero inoxidable (30 mm)</b>	SCI
	<b>Arrotondamento spigolo del piano</b> Corner-rounding for top Angle arrondi pour le plan de travail Abgerundete Kanten der Arbeitsplatte Angulo redondeado de la encimera	
	<b>Corian®</b>	ARC
	<b>Vetro / Glass / Verre / Glas / Vidrio</b>	ARV
	<b>Stratificato / Stratified / Stratifié / Schichtstoff / Estratificado</b>	ARS
	<b>Laminato / Laminate / Laminé / Laminat / Laminado</b>	ARP
	<b>Laminato Fenix® / Laminato Fenix® / Laminé Fenix® / Laminat Fenix® / Laminado Fenix®</b>	ARF
	<b>Acciaio inox / Stainless steel / Acier Inox / Edelstahl / Acero inoxidable</b>	ARI
	<b>Taglio obliquo su piano</b> Special cut of top Découpe spéciale sur le plan de travail Sonderschnitt der Arbeitsplatte Corte especial sobre la encimera	
	<b>Corian®</b>	TSC
	<b>Vetro / Glass / Verre / Glas / Vidrio</b>	TSV
	<b>Stratificato / Stratified / Stratifié / Schichtstoff / Estratificado</b>	TSS
	<b>Laminato / Laminate / Laminé / Laminat / Laminado</b>	TSP
	<b>Laminato Fenix® / Laminato Fenix® / Laminé Fenix® / Laminat Fenix® / Laminado Fenix®</b>	TSF
<b>Acciaio inox / Stainless steel / Acier Inox / Edelstahl / Acero inoxidable</b>	TSI	
	<b>Taglio a "L" su piano</b> Special cut of top Découpe spéciale sur le plan de travail Sonderschnitt der Arbeitsplatte Corte especial sobre la encimera	
	<b>Corian®</b>	T1C
	<b>Vetro / Glass / Verre / Glas / Vidrio</b>	T1V
	<b>Stratificato / Stratified / Stratifié / Schichtstoff / Estratificado</b>	T1S
	<b>Laminato / Laminate / Laminé / Laminat / Laminado</b>	T1P
	<b>Laminato Fenix® / Laminato Fenix® / Laminé Fenix® / Laminat Fenix® / Laminado Fenix®</b>	T1F
<b>Acciaio inox / Stainless steel / Acier Inox / Edelstahl / Acero inoxidable</b>	T1I	

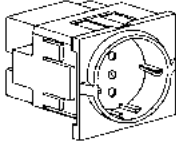
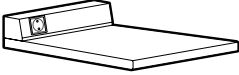
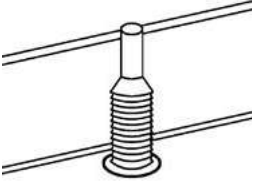
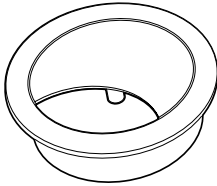
	<b>Descrizione / Description</b> Description / Beschreibung / Descripción	<b>M<sup>3</sup></b> <b>Kg</b>	<b>Articolo</b> Item / Article Artikel / Artículo
	<b>Foro Ø 150 mm su piano, per rifiuti</b> Waste hole Ø 150 mm for top Trou passage déchets Ø 150 mm, pour plan Abfallloch Ø 150 mm für Arbeitsplatte Agujero Ø 150 mm para la basura, sobre encimera		
	<b>Corian®</b>		FRC
	<b>Vetro / Glass / Verre / Glas / Vidrio</b>		FRV
	<b>Stratificato / Stratified / Stratifié / Schichtstoff / Estratificado</b>		FRS
	<b>Laminato / Laminata / Laminé / Laminat / Laminado</b>		FRT
	<b>Laminato Fenix® / Laminata Fenix® / Laminé Fenix®</b> Laminat Fenix® / Laminado Fenix®		FRF
	<b>Acciaio inox / Stainless steel / Acier Inox</b> Edelstahl / Acero inoxidable		FRI
	<b>Telaio supporto piano a sbalzo per piani Corian®, vetro, stratificato: al metro lineare</b> Frame to support the top in Corian®, glass, stratified Châssis pour soutenir le plan en Corian®, verre, stratifié Rahmen für Arbeitsplatte aus Corian®, Glas, Schichtstoff Frame para apoyar las encimeras de Corian®, vidrio, estratificado		STS
	<b>Alzatina bianca: al metro lineare</b> White splashback: per meter Dossieret blanc: au mètre Weiße Aufkantung: je Meter Alzada blanca: al m.	- 0,5	ALB
	<b>Canalina tecnica: al metro lineare (min. P. 505 mm)</b> Raceway: per meter (min. D. 505 mm) Canalisation technique: au mètre (min. P. 505 mm) Technikkanal: je Meter (min. T. 505 mm) Canal técnico: al m. (min. P. 505 mm)		
<b>P 20 x H 45 mm</b>			
		- 1,2	CVE
<b>P 63 x H 75 mm</b>		- 1,2	CCE
	<b>Alluminio / Aluminium / Aluminium / Aluminium / Aluminio</b>		
	<b>Corian®</b>		

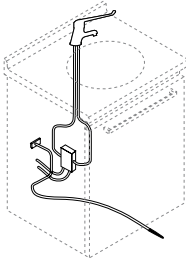
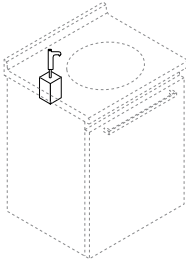
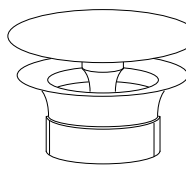
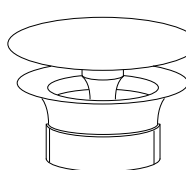
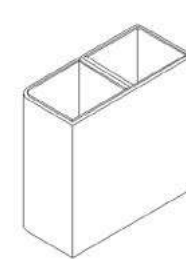
	Descrizione / Description Description / Beschreibung / Descripción	M <sup>3</sup> Kg	Articolo Item / Article Artikel / Artículo
	<b>Presa di corrente per canalina tecnica CVE</b> Socket for CVE Prise de courant pour CVE Steckdose für CVE Toma de corriente para CVE		
	<b>Presa francese</b> / French socket		PCF
	<b>Presa svizzera</b> / Swiss socket		PCH
	<b>Schuko</b>		PCS
	<b>Piano estraibile con 1 presa di corrente Schuko</b> Pull-out shelf with 1 Schuko socket Tirette avec 1 prise de courant Schuko Auszug ausgestattet mit 1 Schuko-Steckdose Estante extraíble con 1 toma de corriente Schuko	-	PE/3
		4	(L 300 mm)
<b>L 300/400 x P 400 x H 135 mm</b>		-	PE/4
		5	(L 400 mm)
	<b>Siringa aria a scomparsa sul piano</b> Hide-away air syringe for top Soufflette air escamotable sur le plan Versenkbare Luftdüse auf der Arbeitsplatte Jeringa de aire escamoteable sobre la encimera		SAR
	<b>Boccola passacavo con chiusura</b> Cable bush with plug Manchon passe-câbles avec fermeture Kabeldurchführung mit Verschluss Casquillo pasacables con cierre		BOP
<b>Ø 60 mm</b>			

	<b>Descrizione</b> / Description Description / Beschreibung / Descripción	<b>M<sup>3</sup></b> <b>Kg</b>	<b>Articolo</b> Item / Article Artikel / Artículo
	<b>Kit comando elettromagnetico 24V</b> 24V electromagnetic control kit Kit commande électromagnétique 24V pour l'eau Elektromagnetischer Wasserauslöser 24V Kit de control electromagnético 24V	<b>START</b> - ----- 1	KELS
		<b>LOOK VELA</b> - ----- 1	KELV
	<b>Distributore di sapone</b> Soap dispenser Distributeur de savon Seifenspender Distribudor de jabón	- ----- 0,24	DSA
	<b>Piletta scarico libero</b> Waste Fuite Drain Vaciador	- ----- -	PIL02
	<b>Piletta Click-Clack</b> Click-Clack waste Click-Clack fuite Drain Klick-Klack Vaciador Click-Clack	- ----- -	PIL01
	<b>Portarifiuti doppio per modulo sottolavello</b> Double rubbish bin for sink unit Poubelle double pour module lavabo Doppelabfalleimer für Waschbeckenschrank Doble cubo de basura para el módulo lavabo	- ----- 2,5	POD

L 370 x P 200 x H 380 mm

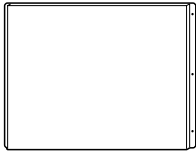
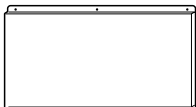
	<b>Descrizione / Description</b> Description / Beschreibung / Descripción	<b>M<sup>3</sup></b> <b>Kg</b>	<b>Articolo</b> Item / Article Artikel / Artículo
	<p><b>Pannello di chiusura da 70 a 150 mm</b></p> <p>Closing panel from 70 to 150 mm</p> <p>Cache de fermeture de 70 à 150 mm</p> <p>Verschlussverkleidung von 70 bis 150 mm</p> <p>Panel de cierre desde 70 hasta 150 mm</p>		PC1
<b>H min 610 - H max 885 mm</b>			
	<p><b>Pannello di chiusura da 160 a 250 mm</b></p> <p>Closing panel from 160 to 250 mm</p> <p>Cache de fermeture de 160 à 250 mm</p> <p>Verschlussverkleidung von 160 bis 250 mm</p> <p>Panel de cierre desde 160 hasta 250 mm</p>		PC2
<b>H min 610 - H max 885 mm</b>			
	<p><b>Pannello di chiusura ad angolo</b></p> <p>Corner closing panel</p> <p>Cache de fermeture pour angle</p> <p>Eckverschlussverkleidung</p> <p>Panel de cierre en ángulo</p>		PC3
<b>H min 610 - H max 885 mm</b>			
	<p><b>Pannello chiusura posteriore ai mobili: al metro lineare</b></p> <p>Furniture back panel: per meter</p> <p>Cache arrière meubles: au mètre</p> <p>Hintere Platte: je Meter</p> <p>Panel de cierre posterior: al m.</p>		PC4
<b>H min 610 - H max 885 mm</b>			
	<p><b>Pannello chiusura inox fra piano e pensili: al metro lineare</b></p> <p>Stainless steel closing panel between top and suspended units: per meter</p> <p>Panneau de jonction en acier inox entre plan et éléments muraux: au mètre</p> <p>Edelstahlverschlussverkleidung zwischen Arbeitsplatte und Hängeschränken: je Meter</p> <p>Panel de cierre de acero entre encimera y elementos colgantes: al m.</p>		PC5
<b>P 20 x H 500 mm</b>			

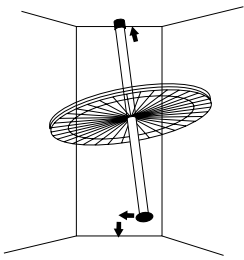
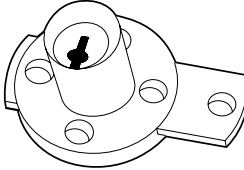
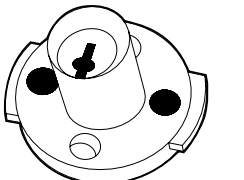
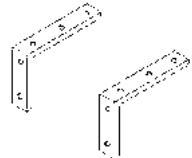
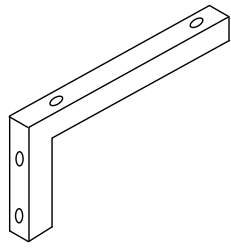
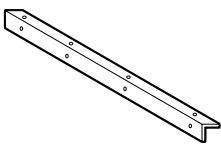
	<b>Descrizione / Description</b> Description / Beschreibung / Descripción	<b>M<sup>3</sup></b> <b>Kg</b>	<b>Articolo</b> Item / Article Artikel / Artículo
 <p>Ø 650 mm</p>	<p><b>Cestello rotante inox per mobile angolare</b></p> <p>Stainless steel swivel basket for corner unit</p> <p>Casier roulant en inox pour module d'angle</p> <p>Drehkorb aus Edelstahl für Eckschrank</p> <p>Cesto giratorio de acero inoxidable para módulo angular</p>	-	CRA
	<p><b>Serratura per serie cassetti</b></p> <p>Lock for set of drawers</p> <p>Serrure pour série de tiroirs</p> <p>Sicherheitsschloß für Schubladen</p> <p>Cerradura para serie de cajones</p>		SEC
	<p><b>Serratura per portina</b></p> <p>Door lock</p> <p>Serrure pour porte</p> <p>Sicherheitsschloß für Tür</p> <p>Cerradura para puerta</p>		SEP
	<p><b>Coppia staffe di sostegno mensola</b></p> <p>Double shelf brackets</p> <p>Paire d'équerres de support pour étagère</p> <p>Doppelstützbügel für Regal</p> <p>Par de estribos de sostén de la repisa</p>		CSM
 <p>L 40 x P 260 x H 180 mm L 40 x P 320 x H 240 mm L 40 x P 440 x H 180 mm L 40 x P 540 x H 240 mm</p>	<p><b>Supporto mensola in tubo quadro cromato</b></p> <p>Chromed shelf brackets</p> <p>Equerre chromée de support pour étagère</p> <p>Verchromte Stützbügel für Regal</p> <p>Estribo cromado de sostén de la repisa</p>	SMC5 (P 260 mm)	SMC2 (P 320 mm)
		SMC1 (P 440 mm)	SMC4 (P 540 mm)
 <p>L 350 x P 40 x H 40 mm</p>	<p><b>Squadretta a "L" di sostegno piano</b></p> <p>"L" top bracket</p> <p>Equerre à "L" de soutien pour plan</p> <p>"L-förmige" Stützbügel für Arbeitsplatte</p> <p>Estribo en "L" de sostén de la encimera</p>		SSL

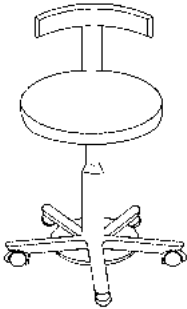
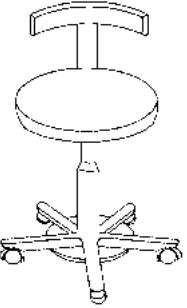
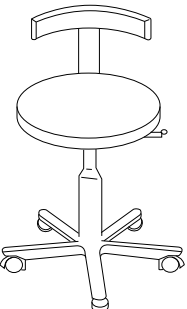
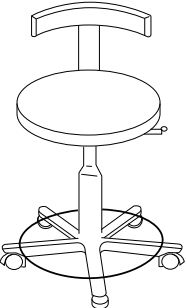
	<b>Descrizione / Description</b> Description / Beschreibung / Descripción	<b>M<sup>3</sup></b> <b>Kg</b>	<b>Articolo</b> Item / Article Artikel / Artículo
	<p><b>Seggiolino per odontoiatra con schienale girevole e alzata a gas tramite pedale</b></p> <p>Dentist's seat with swivel back and pedal-operated height-adjustment</p> <p>Tabouret opérateur avec dossier pivotant et réglage hauteur par commande à pédale</p> <p>Zahnarztstuhl mit pendelnd gelagerter Rückenlehne und Pedalbedienung</p> <p>Silla para dentista con respaldo giratorio y mando del pedal</p>	<p>0,70</p> <hr style="width: 50%; margin: 0 auto;"/> <p>11,5</p>	SOD
<p><b>H min 450 - H max 600 mm</b></p>			
	<p><b>Seggiolino per assistente con schienale girevole e alzata a gas tramite pedale</b></p> <p>Assistant's seat with swivel back and pedal-operated height-adjustment</p> <p>Tabouret assistant avec dossier pivotant et réglage hauteur par commande à pédale</p> <p>Zahnarztshelferinnenstuhl mit pendelnd gelagerter Rückenlehne und Pedalbedienung</p> <p>Silla para ayudante con respaldo giratorio y mando del pedal</p>	<p>0,70</p> <hr style="width: 50%; margin: 0 auto;"/> <p>13</p>	SOD/A
<p><b>H min 550 - H max 700 mm</b></p>			
	<p><b>Seggiolino per odontoiatra con schienale fisso e alzata a gas tramite leva</b></p> <p>Dentist's seat with fixed back and lever-operated height-adjustment</p> <p>Tabouret opérateur avec dossier fixe et réglage hauteur par commande à levier</p> <p>Zahnarztstuhl mit feststehender Rückenlehne und Hebelbedienung</p> <p>Silla para dentista con respaldo fijo y mando de la palanca</p>	<p>0,10</p> <hr style="width: 50%; margin: 0 auto;"/> <p>10</p>	SOL
<p><b>H min 550 - H max 650 mm</b></p>			
	<p><b>Seggiolino per odontoiatra con schienale fisso, alzata a gas tramite leva e appoggiapiedi</b></p> <p>Dentist's seat with fixed back, lever-operated height-adjustment and footrest</p> <p>Tabouret opérateur avec dossier fixe, réglage hauteur par commande à levier et appuie-pieds</p> <p>Zahnarztstuhl mit feststehender Rückenlehne, Hebelbedienung und Fußstütze</p> <p>Silla para dentista con respaldo fijo, con mando de la palanca y reposapiés</p>	<p>0,10</p> <hr style="width: 50%; margin: 0 auto;"/> <p>11</p>	SOL/A
<p><b>H min 550 - H max 650 mm</b></p>			

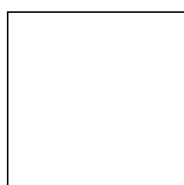

**RAL 9010**

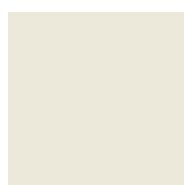

**RAL 9002**



**RAL 7035**



**RAL 1015**



**RAL 7005**



**RAL 9005**



**RAL 1018**



**RAL 3022**



**RAL 3526**



**RAL 5024**



**RAL 5012**



**RAL 5005**



**RAL 5013**



**RAL 6033**



**RAL 6000**



**RAL 6027**

Questo campionario deve essere considerato solo come guida indicativa del colore e non può essere utilizzato come riferimento originale per la produzione e la valutazione di superfici colorate.

This sample should only be considered as an indicative colour guide and cannot be used as an original reference for the production and assessment of colored surfaces.

Ce nuancier ne sert qu'à donner une idée des différents coloris et ne doit en aucun cas être utilisé comme référence originale pour la production et l'évaluation des surfaces colorées.

Diese Farbmuster sind unverbindlich und können vom Original Farbton der hergestellten Oberflächen abweichen.

Esta muestra de colores debe considerarse sólo como una guía indicativa del color, y no puede utilizarse como referencia original para la producción y evaluación de las superficies pintadas.



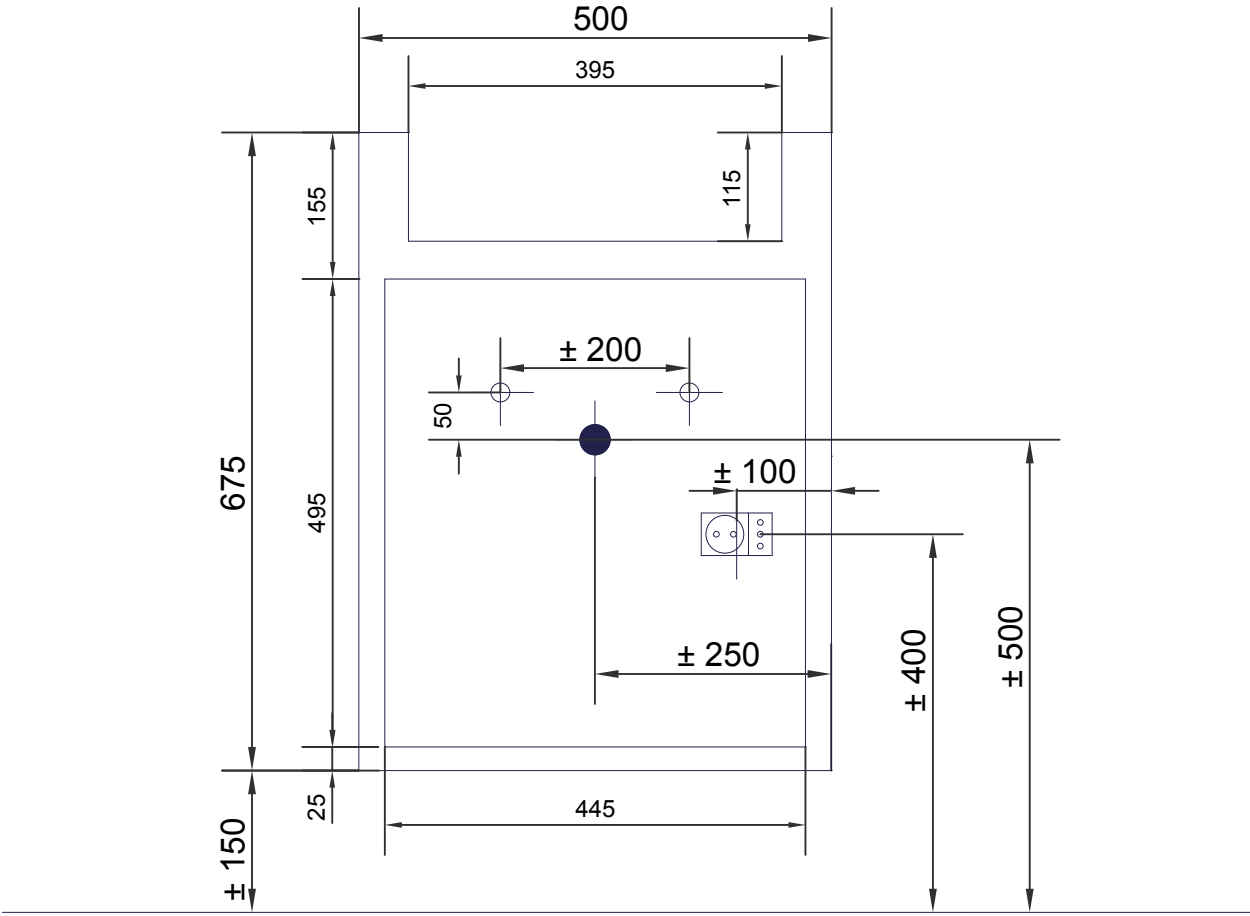

# CONDIZIONI GENERALI DI VENDITA

General terms of sale / Conditions generales de vente

Allgemeine Verkaufsbedingungen / Condiciones generales de venta



Il presente listino sostituisce e annulla tutti i precedenti e può essere modificato in qualsiasi momento senza preavviso. I prezzi si intendono al netto di iva. **L'imballo non è compreso nel prezzo.** L'installazione è a carico del cliente.

L'ordine, e ogni modifica ad esso, dovrà essere inoltrato per iscritto e sarà da considerarsi accettato solo dopo l'invio di una conferma da parte di Loran srl. I termini fissati per la spedizione non sono tassativi e in nessun caso potranno costituire pretesto per ritardi di pagamento o richiesta di risarcimento.

**La merce viaggia a rischio e pericolo del committente, franco stabilimento Loran srl a Pieve di Soligo.** Se non indicato per iscritto, la merce sarà spedita col mezzo ritenuto più opportuno da Loran srl. **Eventuali reclami di trasporto devono essere fatti al momento della consegna direttamente al vettore.**

Eventuali difetti di fabbricazione devono essere comunicati a mezzo raccomandata alla sede Loran srl di Pieve di Soligo entro 8 giorni dalla data di ricevimento merce, anche se segnalati prima in altra forma. In ogni caso non danno diritto al cliente di sospendere i pagamenti.

Nessun materiale dovrà essere reso senza nostra autorizzazione scritta. I resi autorizzati ci dovranno pervenire in porto franco accompagnati da documento di trasporto che indichi il numero e la data della fattura relativa alla fornitura originaria e saranno gravati del 15% per spese generali.

Il materiale di produzione Loran srl ha garanzia di anni due, salvo eventuali danni o manomissioni causati dall'utilizzatore.

La merce venduta rimane di proprietà della venditrice fino al pagamento totale da parte dell'acquirente. In caso contrario la venditrice si riserva la facoltà di ritirarla in qualsiasi momento. Ogni controversia sarà competenza del foro di Treviso (Italia)

This price list can be modified at any time, without notice. The prices do not include vat. **Packing is not included in the price.** Installation shall be charged to the customer.

Order as well as any modifications of such orders shall be made in writing and shall be considered accepted upon our written confirmation. Delivery terms are not binding and under no circumstance may they be used as a pretext to justify delays in payment or claims for compensation.

**The goods travel at the purchaser's risk on a ex-works basis from our factory in Pieve di Soligo (Italy):** unless otherwise specified in writing, the goods will be shipped with the means of transport considered most suitable by our company. The goods shall be checked by the receiver as soon as they reach their destination and **any claim for damages shall be filed directly with the carrier.**

Any manufacturing fault shall be immediately communicated by registered letter to our offices in Pieve di Soligo within 8 days after the goods have been received, and may also be communicated in other additional ways. By no means shall manufacturing defects entitle the purchaser to stop payments.

No goods shall be returned without our written authorization. Authorized returned goods shall be sent to us free port, together with a "returned goods" note showing the number and date of our original invoice related to such. 15% of total value shall be charged to our customer.

All Loran products are guaranteed for two years. The warranty shall no longer be valid if the product has been damaged or tampered with by the user.

Goods sold remain property of the seller until fully paid by the buyer. Should this not be the case, the seller shall be entitled to withdraw its goods at any time. In the event of any and all disputes, competent court shall exclusively be the court of Treviso (Italy).

# CONDIZIONI GENERALI DI VENDITA

General terms of sale / Conditions generales de vente

Allgemeine Verkaufsbedingungen / Condiciones generales de venta



Cette liste de prix est susceptible d'être modifiée à n'importe quel moment sans préavis. Les prix sont exprimés HT. **Les prix ne comprennent pas l'emballage.** L'installation est à la charge du client.

La commande, et toute modification éventuelle à celle-ci, devra être transmise par écrit et ne pourra être considérée acceptée qu'après l'envoi d'une confirmation écrite de notre part. Les délais fixés pour l'expédition ne constituent pas un terme de rigueur et ne pourront en aucun cas constituer prétexte pour retarder les paiements ou pour exiger un remboursement ou des dommages.

**La marchandise voyage aux risques et périls du client, franco départ-usine Loran srl de Pieve di Soligo (Italie):** en absence d'instructions écrites précises de la part du client, la marchandise sera envoyée par le moyen que nous jugerons le plus indiqué. **Les éventuelles réclamations concernant le transport devront être faites directement au transporteur au moment même de la livraison.**

Les éventuels défauts de fabrication devront être signalés, par lettre recommandée dans les 8 jours à compter de la date de réception de la marchandise, à Loran srl de Pieve di Soligo; et cela, même si déjà signalés au travers un autre moyen ou forme. De toute façon, il est entendu qu'une éventuelle réclamation ne donne en aucun cas le droit au client d'interrompre les paiements.

Aucun matériel ne pourra être rendu sans notre autorisation écrite. Les retours autorisés de marchandise devront nous parvenir franco de port et munis d'un bulletin de transport officiel indiquant entre autre le numéro et la date de la facture relative à la commande d'origine. Il est entendu que les marchandises rendues seront grevées de 15% pour cause de frais généraux.

Le matériel de Loran srl production bénéficie d'une garantie 2 ans, sujette à déchéance en cas de dégâts provoqués par l'utilisateur ou, de quelque manière, imputables à celui-ci.

Il est entendu que jusqu'au paiement complet par de l'acheteur de la marchandise vendue, celle-ci reste la propriété de l'entreprise vendeuse qui aura donc la faculté de retirer la marchandise à n'importe quel moment en cas de défaut, même partiel, de paiement. Il est entendu que tout différent ou litige entre les parties sera du ressort du tribunal de Treviso (Italie).

Diese Preisliste kann jederzeit und ohne Vorankündigung geändert werden. Die Preise verstehen sich zuzüglich Mehrwertsteuer. **Die Preise verstehen sich ausschließlich Verpackung.** Die Installation erfolgt auf Kosten des Kunden.

Der Auftrag und jede diesbezügliche Änderung hat schriftlich zu erfolgen und gilt erst nach unserer Auftragsbestätigung als angenommen. Die Lieferdaten sind nicht bindend und berechtigen keinesfalls zu Zahlungsverzögerungen oder Schadenersatzforderungen.

**Die Ware reist auf alleinige Gefahr des Auftraggebers ab unserem Firmensitz in Pieve di Soligo (Italien):** falls nicht anders schriftlich vereinbart, wird die Ware mit dem von uns als geeignet erachteten Transportmittel befördert. **Eventuelle Beanstandungen bezüglich des Transports sind bei der Anlieferung direkt dem Frachtführer zu melden.**

Fabrikationsfehler sind unserem Firmensitz in Pieve di Soligo innerhalb von 8 Tagen nach Erhalt der Ware per Einschreiben zu melden, auch wenn Sie vorher bereits in anderer Form mitgeteilt wurden. In jedem Fall berechtigen Sie den Kunden nicht zur Einstellung der Zahlungen.

Materialrückstellungen dürfen nur mit unserer schriftlichen Genehmigung erfolgen. Die genehmigten Rückstellungen haben Frachtfrei mit einem Transportschein zu erfolgen, auf dem die Rechnungsnummer und das Rechnungsdatum bezüglich der ursprünglichen Lieferung vermerkt sind, wobei 15% für allgemeine Kosten berechnet werden.

Das Material von Loran srl hat eine zweijährige Garantie, außer bei Schäden oder unsachgemäßer Behandlung durch den Anwender.

Die verkaufte Ware bleibt Eigentum des Verkäufers bis zur vollständigen Zahlung seitens des Käufers. Andernfalls behält sich der Verkäufer das Recht vor, die Ware jederzeit abzuholen. Für jegliche Streitigkeiten ist das Gericht von Treviso (Italien) zuständig.

La presente lista de precios puede ser modificada en cualquier momento y sin previo aviso. Los precios se consideran sin IVA. **El embalaje no está incluido en el precio.** La instalación está a cargo del cliente.

El pedido, y toda modificación del mismo, se deberá enviar por escrito y se considerará aceptado sólo después del envío de una confirmación por parte de Loran srl. Los plazos fijados para la expedición no son taxativos y en ningún caso podrán constituirse en un pretexto para retrasar el pago o pedir resarcimiento.

**La mercancía viaja por cuenta y riesgo del cliente, desde Loran srl en Pieve di Soligo (Italia).** Si no estuviera especificado por escrito, la mercancía será enviada por el medio de transporte considerado más conveniente por Loran srl. **Eventuales reclamos por el transporte se deberán realizar en el momento de la entrega directamente al transportista.**

Los defectos de fabricación deberán comunicarse mediante carta certificada a la sede de Loran srl de Pieve di Soligo, dentro de los 8 días a partir de la fecha de recepción de la mercancía, incluso si se comunicaron antes por otro medio. En cualquier caso esto no otorga derecho al cliente para suspender los pagos.

Ningún material podrá entregarse sin nuestra autorización escrita. Las entregas autorizadas deberán realizarse en puerto franco acompañadas por el documento de transporte que indique el número y la fecha de la factura correspondiente al suministro original y estarán gravados con 15% para gastos generales.

El material producido por Loran srl tiene una garantía de dos años, excepto eventuales daños o alteraciones causados por el usuario.

La mercancía vendida continuará perteneciendo al vendedor hasta el pago total por parte del comprador. En caso contrario el vendedor se reserva la facultad de retirarla en cualquier momento. Toda controversia será competencia de los tribunales de Treviso (Italia).

**Loran**  
*everyday passion*



**LORAN srl** • Via della Lira, 397 zona ind. • 31053 Pieve di Soligo • TV • Italy  
Tel. +39 0438 842603 • Fax +39 0438 980233 • [loran@loran.it](mailto:loran@loran.it) • [www.loran.it](http://www.loran.it)